

# What weather variables are important for wet and slab avalanches under a changing climate in low altitude mountain range in Czechia?

Markéta Součková<sup>1,2</sup>, Roman Juras<sup>1</sup>, Kryštof Dytrt<sup>1</sup>, Vojtěch Moravec<sup>1,2</sup>, Johanna Ruth Blöcher<sup>1</sup>, and Martin Hanel<sup>1,2</sup>

<sup>1</sup>Faculty of Environmental Sciences, Czech University of Life Sciences Prague, Kamýčká 129, Praha – Suchbátka, 165 00, Czechia

<sup>2</sup>T.G. Masaryk Water Research Institute, Department of Hydrology, Podbabská 2582/30, 160 00 Prague 6, Czechia

**Correspondence:** Markéta Součková (souckovamarketa@fzp.czu.cz)

## Abstract.

Climate change impact on avalanches is ambiguous. Fewer, wetter, and smaller avalanches are expected in areas where snow cover is declining, while in higher altitude areas where snowfall prevails, snow avalanches are frequently and spontaneously triggered. In the present paper, we 1) analyse trends in frequency, magnitude and orientation of wet and slab avalanche activity 5 during 59 winter seasons (1962–2021), and 2) detect main meteorological and snow drivers of wet and slab avalanches for winter seasons from 1979 to 2020 using machine learning techniques: decision trees and random forest with a tool that can balance the avalanche and non-avalanche days dataset. In terms of avalanches, low to medium-high mountain ranges are neglected in the literature. Therefore we focused on the low altitude Czech Krkonoše Mountain range (Central Europe). The analysis is based on an avalanche dataset of 60 avalanche paths. The number and size of wet avalanches in February and March 10 has increased, consistent with the current literature, while the number of slab avalanches has decreased in the last three decades. More wet avalanche releases might be connected to winter season air temperature as it has risen by 1.8 °C since 1979.

The RF results indicate that wet avalanches are influenced by 3-day maximum and minimum air temperature, snow depth, wind speed, wind direction, and rainfall. Slab avalanche activity is influenced by snow depth, rainfall, new snow, and wind speed. Based on the balanced RF method, air temperature-related variables for slab avalanches were less important than rain 15 and snow-related variables. Surprisingly, the RF analysis revealed a less significant than expected relationship between new snow sum and slab avalanche activity. Our analysis allows the use of the identified wet and slab avalanche driving variables to be included in the avalanche danger levels alerts. Although it cannot replace operational forecasting, machine learning can allow for additional insights for the decision-making process to mitigate avalanche hazard.

## 1 Introduction

20 Snow avalanches are major natural hazards. As rapidly moving snow masses, snow avalanches pose a serious threat to people, property, and infrastructure. The growth in popularity of winter tourism has led to an increase in numbers of avalanche accidents

(Techel et al., 2016). Although climate change is happening, its effect on snow avalanches remain unclear (Strapazzon et al., 2021). The frequency and types of snow avalanches may change (Hock et al., 2019). A wetter, warmer climate could exacerbate the consequences of burial (Strapazzon et al., 2021). This is why it is vital to analyse how a changing climate has impacted  
25 avalanches.

Zgheib et al. (2020) suggests that social-economic, environmental changes, and anthropogenic drivers may be the primary factors driving the spatiotemporal evolution of the risk rather than just changes in hazard (meteorological conditions, snow stratigraphy). Changes in land use and land cover, such as deforestation (García-Hernández et al., 2017) and reforestation (Zgheib et al., 2020, 2022), as well as changes in demographics (Giacona et al., 2018) will affect avalanche risk. Avalanche  
30 types and avalanche frequency are affected by a combination of precipitation amounts and air temperatures during storms, and prior snow stratigraphy (Schweizer et al., 2009). Winter recreationists face a significant threat due to the presence of persistent weak layers (Techel et al., 2015; Statham et al., 2018). Despite a likely decrease in overall avalanche frequency (Strapazzon et al., 2021), more extreme precipitation events during winter storms can cause more intensive avalanche activity. Large-magnitude regional avalanche years have historically been characterized by stormy winters with favorable snowpack  
35 anomalies; however, in recent decades, warmer temperatures and a shallow snowpack have become increasingly influential in the Rocky Mountains (Peitzsch et al., 2021). Avalanche activity is governed by both variable and permanent factors (Quervain et al., 1973). Whereas, variable factors are attributed to meteorological conditions (for instance rain, air temperature, wind, snowfall) that progressively build the snowpack, permanent factors are attributed to terrain features (elevation, slope, aspect, roughness of the ground, etc.) (Sielenou et al., 2021).

40 The overall number and runout distance of snow avalanches will reduce in regions and elevations experiencing a significant reduction in snow cover. There is medium evidence and high agreement that observed changes in avalanches in mountain regions will be exacerbated in the future (Hock et al., 2019), with generally a decrease in hazard (Martin et al., 2001) at lower elevations. However less snow does not necessarily result in fewer avalanches (Ballesteros-Cánovas et al., 2018; Reuter et al., 2020; Peitzsch et al., 2021). At higher elevations, mixed changes are expected, with more wet snow avalanches. Wet  
45 snow avalanches will occur more frequently even in winter, which has already been shown for recent decades from December to February (Naaim et al., 2016). Since wet-snow avalanches are more likely to occur early in the season, spring avalanche activity at lower elevations is likely to decrease, while avalanche activity at higher elevations is likely to increase (Castebrunet et al., 2014; Strapazzon et al., 2021). There is no clear direction in the trend for overall avalanche activity (Hock et al., 2019), however at local scale (e.g. NE France, Vosques mountains) observed upslope migration of snow avalanches in a warming  
50 climate with release areas > 1,200 m a.s. (Giacona et al., 2021). Ballesteros-Cánovas et al. (2018) reported increased frequency of wet avalanche activity on some slopes of the Western Indian Himalaya over recent decades. In the European Alps and Tatra mountains, avalanche mass and run-out distance have decreased at lower elevation as well as powder avalanches. Avalanche numbers have decreased below 2000 m a.s.l., and increased above this elevation (Eckert et al., 2013; Lavigne et al., 2015; Gądek et al., 2017).

55 Focusing on wet-snow avalanches, three triggering mechanisms exists (or their combinations) due to loss of strength, overloading and gradual weakening (Baggi and Schweizer, 2009). More specifically, loss of strength can be caused by infiltration

and accumulation of water at capillary barriers. Overloading can occur due to precipitation of partially wet and weakened snowpack. Lastly, the gradual weakening of the basal snowpack can occur as the snowpack becomes isothermal, causing failure of the basal layers. This can be caused by heat stored in the ground that melts the lowermost snow layer. The most frequent are slab avalanches (Schweizer and Föhn, 1996), which are wet or dry. Mountain regions worldwide are susceptible to wet snow and slab avalanche types (Soteres et al., 2020). Natural slab avalanches are triggered either due to gradual uniform loading by precipitation and wind (or by a combination of both), or due to a non-loading situation that changes the snowpack properties, such as surface warming (Schweizer et al., 2003).

Climate change influences mountain snow cover by increase in air temperature and rainfall during the winter. Depending on elevation, air temperature increases may cause changes in the type, intensity, and frequency of snowfall (Strapazzon et al., 2021). At higher elevations, air temperatures will rise and rain will occur more often. At lower elevations, snowfall is less frequent and intense, resulting in a thinner, wetter snowpack with a higher average density according to Intergovernmental Panel on Climate change (IPCC) special report Hock et al. (2019). When snow cover decreases, avalanche hazard areas also decrease (Strapazzon et al., 2021). At high elevations (high mountain areas, distinct regions, where snow is a prominent feature of the landscape, without exact and quantitative separation line), the likelihood of more dynamic changes in temperature and precipitation is higher, with accelerated fluctuations between extremes and with less prominent trends because of local effects (Hock et al., 2019). The avalanche regime may be less impacted at higher elevations, where snowfall is still abundant and may increase in intensity (Laute and Beylich, 2018; Hock et al., 2019; Le Roux et al., 2021). At high altitude, trends in extreme snowfall are increasing above 2000 m a.s.l. in the French Alps (Le Roux et al., 2021), however with spatially contrasting pattern implied around 2500 m north and south part of France, possibly resulting from climate warming and circulation patterns. The observed shift from solid to liquid precipitation is likely to move the position of seasonal snow lines to higher elevations, and shorten snow seasons (Marty et al., 2017; Beniston et al., 2018; Giacomoni et al., 2021). Globally, snowfall has reduced as a result of increasing temperatures, especially at lower elevations (Hock et al., 2019). Regional trends of increasing liquid precipitation during winter were confirmed (Feng and Hu, 2007; Bintanja, 2018). Moreover, a decrease in snowfall fraction ( $S_f$ ) of  $-5.5 \% \times \text{decade}^{-1}$  in low altitude mountain catchments ( $> 900 \text{ m}$ ) in Czechia and Slovakia has been observed since 1966 (Blahušáková et al., 2020). From Synop (surface synoptic observations) reports the precipitation phase in the cold season has partially shifted from solid to mixed precipitation, with the most substantial decrease in snowfall in February ( $-10.5 \% \times \text{decade}^{-1}$ ) and January ( $-6.3 \% \times \text{decade}^{-1}$ ) from 1983-2018 in Czech meteorological stations (Hynčica and Huth, 2019).

Trends of snowpack properties such as snow depth (SD), snow water equivalent (SWE), and snow characteristics (e.g. snow cover extend (SCE), and snow cover duration (SCD)) serve as the main proxies for the detection of future snow avalanche activity in many regions. Changes projected for the mountain cryosphere indicate a decrease in SCE and SCD (Notarnicola, 2020). SWE and SD have declined in nearly all regions by  $-5 \% \times \text{decade}^{-1}$  on average. This trend is apparent especially at lower elevations, although year-to-year variation is high (Hock et al., 2019). Overall, snow cover duration has shortened in Czech mountain catchments over recent decades by up to  $-6.8 \text{ days} \times \text{decade}^{-1}$ , principally due to earlier melt out (Blahušáková et al., 2020). Results of Nedelcev and Jeníček (2021) showed that snowpack at elevations below 1200 m a.s.l. seems to

be more sensitive to changes in air temperature, while precipitation influenced the snowpack more at elevations above 1200 m a.s.l. In Central Europe snow depth has been declining by 1 % at higher elevations (~2300 m a.s.l.) and 6.3 % at lower elevations (~800 m a.s.l.) since 1966 (Blahušiaková et al., 2020). Climate models suggest that snow season will be shortened by 25  
95 days in Czechia from 2021 to 2040; simulations can be seen at Klimatická Změna.cz.

Avalanche analyses related to meteorological and snow parameters of a) wet snow avalanche were investigated by Baggi and Schweizer (2009); Peitzsch et al. (2012); Bellaire et al. (2017); b) slab avalanches were investigated by Eckerstorfer and Christiansen (2011); Marienthal et al. (2015); Bellaire et al. (2017). Different approaches have been used: classification trees (e.g. Hendrikx et al., 2014; Marienthal et al., 2015; Dreier et al., 2016), logistic regression (e.g. Dreier et al., 2016; Gauthier  
100 et al., 2017), and random forest (e.g. Möhle et al., 2014; Sielenou et al., 2021). As the effects of climate change on avalanche types is ambiguous and regional differences are vast, there is a need for understanding how avalanche types change over the time scales, as well as gaining knowledge of triggering variables of wet and slab avalanche activity in a neglected low altitude mountain range (Krkonosé mountains, NE border of Czechia and Poland). Although snow avalanches do not present a significant risk to the population and settlements in Czechia, the rising popularity of winter sports (off piste skiing and ski  
105 touring) in recent years has led to an increase in social exposure to snow avalanches and thus a growing number of victims (11 fatalities, 15 injured, and 28 people pulled down since 2005) (Mou) and, rarely, road accidents. Krkonosé was one of the first non-Alpine regions that established regular snow monitoring and avalanche records in 1961 (Vrba and Spusta, 1975, 1991; Spusta and Kociánová, 1998; Spusta et al., 2003, 2006; Juras et al.; Blahůt et al., 2017), but a decision support model helping avalanche forecasting is missing.

110 Therefore in this study, we aim to 1) analyze changes in avalanche activity: assessment of frequency and magnitude over 59 winter seasons (1962–2021), and 2) determine the main meteorological and snow drivers governing snow avalanche activity of a) wet avalanches and b) slab avalanches for a daily time scale of winter seasons from 1979 to 2020 within the low altitude mountain range in Central Europe, specifically the Krkonosé mountains.

The paper is organized as follows: Section 2 describes the data and methods used in this study. In Section 3, we present the  
115 results. Trends in two avalanche types and the skill of models obtained by machine learning are described and discussed, and different limitations are described in Section 4. In Section 5, we conclude the findings of our study.

## 2 Data and methods

In the following section we describe the Krkonosé Mountains, a low altitude mountain range in Central Europe. We present its geology, geomorphology, land cover, and meteorological conditions. Subsequently, we report on the avalanche activity dataset,  
120 meteorological and snow data, and methods used for estimating the main weather and snow variables determining avalanche activity.

## 2.1 Study area

The Krkonoše Mountains (internationally known as the Giant Mountains), with the highest peak Sněžka at 1602 m a.s.l., is the area with the most frequent snow avalanche activity in Czechia. The Krkonoše mountain range extends between Czechia and Poland, with the larger part located in north-east Czechia. Most of the mountain range belongs to Krkonoše National Park (KRNAP), which covers an area of 550 km<sup>2</sup> and has been protected since 1963.

As part of the Variscan/ Hercynian mountain ranges in Europe, Krkonoše is mainly comprised of crystalline schists with several quartzites and crystalline limestones. The central part (border with Poland) is formed of granites, with Alpine orogeny and Quaternary glaciations that carved out several plateaus at an elevation between 1300 and 1450 m a.s.l. (Blahůt et al., 2017). The plateaus host several headwaters (e.g. Elbe River) and glacial cirques (Engel et al., 2010), where small brooks originate in the vicinity of several avalanche triggering areas and might affect avalanche activity mainly in the snowmelt period. The mean slope of avalanche release areas is 31 ° and mean elevation ranges between 1072 to 1575 m a.s.l.; the avalanche paths are mostly facing east, south-east, south (Fig. 4), (Fig. 8) (mean aspect = 168 °). Released areas were vectorized over the orthophoto/ photos collected in the field and delimited by Krkonoše National Park Administration: KRNAP (Fig. 1).

The biogeographical location of the Krkonoše Mountains consists of a varied mosaic of montane spruce and mixed forests, tall herb meadows, dwarf pine communities, *Nardus* grasslands, sub-arctic peat bogs and lichen tundra. Arcto-alpine tundra covers 4 % of the territory. According to the KRNAP Green Infrastructure map the avalanche release areas consist mainly of alpine meadows (39.7 %), natural cypress (32.7 %) and rocks and scree (21.0 %) (MaG, 2020). A few spruces, peat bogs, and springs are spread in avalanche release areas < 3 %. The tree line lies between 1200–1350 m a.s.l. (Štursa et al., 2010).

Krkonoše is characterised by mean annual air temperature of 0 °C at its highest parts, annual precipitation of about 1200 mm (Tolasz, 2007), of which about 34 % consists of snow (Juras et al., 2021). The mean annual temperature has increased in Krkonoše over the last two decades by 1 °C in comparison with the period 1961–2000 (Kliegrová and Kašičková, 2019). Prevailing westerly winds (resulting in relatively low snow accumulation on the west-facing, wind-ward slopes while steep, lee-ward slopes accumulate much more snow) (Blahůt et al., 2017) favour cornice avalanches, which are common phenomena in Obří Důl avalanche locality. The winds redistribute snow from the upland plateaus of Bílá and Čertova Louka (Vrba and Spusta, 1975). A snow accumulation is governed by winds directed by mountain relief (anemo-orographic system) (Jeník, 1961). The snowpack depths usually range between 100 and 300 cm (Blahůt et al., 2017).

## 2.2 Avalanche activity dataset and data manipulation

Avalanches, as rapidly moving snow masses with a minimum length of 50 metres, have been systematically monitored on 60 avalanche paths in the Czech part of Krkonoše since the 1962 winter season (the first record was actually on the 13th of January 1962) (Spusta et al., 2020) (Fig. 1) by the KRNAP administration, Krkonoše Mountain Rescue Service. Over the recent years, web camera records serve as an assurance if the avalanche was released. However, the cameras are not operating all the time due to freezing. During 59 winter seasons (from 1961 to 2021) 1246 avalanches were recorded on the Czech site of Krkonoše avalanche dataset. We define winter season from 1.10 to 31.5 i.e. 1.10.1961–31.5.1962 is assigned to 1962. Snow

155 avalanches are classified by international codes (Quervain et al., 1973), with a little modification for the Krkonoše mountains. The dimensions of each avalanche are listed in Vrba and Spusta (e.g. 1975, 1991); Spusta and Kociánová (e.g. 1998); Spusta et al. (e.g. 2003, 2020) and (Součková et al., 2022).

In order to know the trend of wet and slab avalanche activity, we filtered two types of avalanches from the avalanche dataset according to the following criteria: zone of origin (known as release area) a) manner of starting (A2 line release zone (271  
160 avalanche records: Aval); A3 soft slab (514 Aval); A4 hard slab (45 Aval), four no value (NA) of avalanche length)), and b) liquid water in snow (C=2, 186 Aval, one NA in avalanche length) according to the avalanche classification (Quervain et al., 1973). We chose two avalanche types. First, the wet avalanche dataset, defined by wet snow (liquid water presence) in a release area, was chosen as an indicator of changing climate, and second, slab avalanches were chosen as the most frequent and dangerous avalanche type for skiers on the Krkonoše Mountains (Schweizer and Föhn, 1996). The selection of these two  
165 avalanche types is also based on avalanche danger models suggested by Mair and Nairz (2011).

Long term trends in frequency, size, and aspect as well as basic weather parameters were analysed for both selected groups. We processed avalanche data characteristics for wet snow and slab avalanches: count and magnitude (avalanche size) of avalanche length. Avalanche activity trends in the avalanche dataset were explored over periods (1962–1991 and 1991–2021) by the Mann-Kendall Tau.

170 We aimed to compare changes in avalanche size. Each recorded avalanche path length was related to the potential maximum avalanche length: 100-year return period (100-yr RP) output from the Rapid Avalanche Mass Movement model (RAMMS) (considering the topography and terrain roughness) (Christen et al., 2010) and were computed by Blahůt et al. (2017) (Fig. 1). This method enabled us to compare avalanche sizes among the path of different lengths objectively.

### 2.3 Meteorological and snowpack data preparation

175 Daily data are freely accessible through the Czech Hydrometeorological Institute (CHMI). We used meteorological data from an automated weather station: Labská bouda (LBOU, 1320 m a.s.l.; Fig. 1). For the purpose of the study, we created two wet and slab avalanche datasets with the variables listed in Table 1. Beside the measured values, we calculated two additional variables representing two different rainfall estimates. There are more methods to determine rainfall from total precipitation. First we used rainfall (Rain\_Tw) based on single threshold wet bulb temperature ( $Tt = -0.5 \text{ }^\circ\text{C}$ ) calculated according to Stull  
180 (2011) formula. Second, rainfall separated from the total precipitation (Rain-Ta) based on single threshold air temperature ( $Tt = +0.46 \text{ }^\circ\text{C}$ ), which was calibrated for the Elbe catchment (Juras et al., 2021). Apart from station measured variables, we generated 3-day moving average windows of the input variables and sums of selected variables (Table 1). By using a moving average, the curve is smoothed and it helps to better identify a trend or trend change; sums highlight the effect. Even though snow water equivalent would be a promising predictor of avalanches, we excluded it from the dataset as it is, unfortunately,  
185 measured only weekly in Czechia, and the interpolated data could be misleading. The winter season was considered as a period from 1 / 10 to 31 / 5 when snow can be observed at the study site.

For the purpose of machine learning analysis, the wet and slab datasets contain the Avalanche day (Ad) and Non avalanche day (NAd) and is linked to available meteorological data since 1979. Ad was defined within the winter season when at least

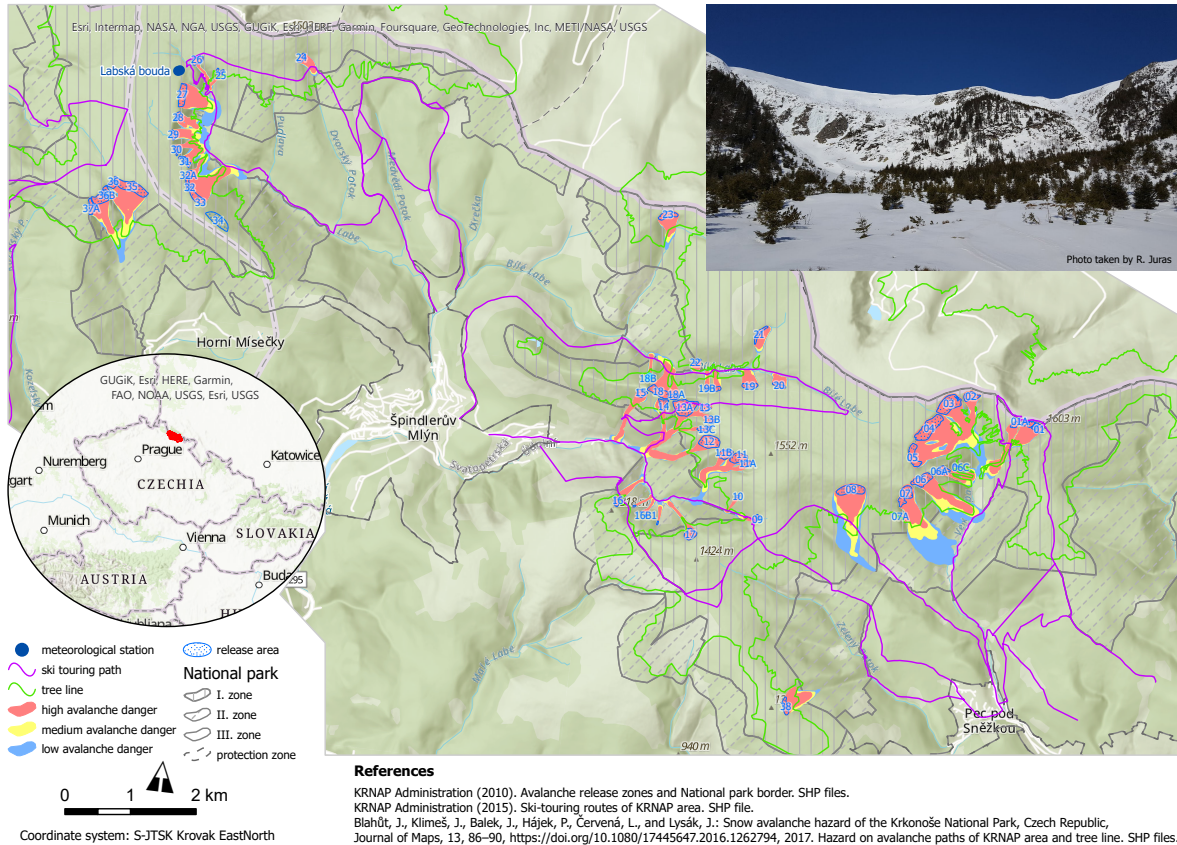

**Fig. 1.** Study location of avalanche activity in the Krkonoše mountains.

one avalanche was recorded and NAd when no avalanche was recorded. We explored the occurrence of avalanches based on  
 190 the course of hydroclimatic variables during the previous six days. NAds that occurred six days after an avalanche record were  
 deleted to minimize the dependency on preconditions between Ad and NAd. Datasets should not contain any missing values as  
 some machine learning algorithms do not deal with them correctly. Therefore, we excluded them using 38 year-long data time  
 series (1979–1999 and 2002–2020 data period; 2000–2001 was omitted) as the station Labská bouda (LBOU) did not operate  
 during 2000–2001. For the trend variable analysis also 1999 and 2002 were excluded as the variables had less than 50 % of data.  
 195 Correlated variables are displayed by dendrograms for wet in Fig. A1 and slab avalanches in Fig. A2. For nonlinear models,  
 colinear variables can remain.

## 2.4 Balancing data, machine learning methods

We analysed the explanatory power of several meteorological and snow variables to explain avalanche triggers for the daily  
 time scale (1979–1999, 2002–2020). We applied tree-based models (Decision Tree: DT, Random Forest: RF) to a) determine

**Table 1.** Description of the weather variables used in this study.

Variable	Abbreviation	Model	Explanation
Snow depth [ <i>cm</i> ]	SD	SD_value	Daily mean snow depth
		SD_value3	3 day moving average of snow depth before avalanche release (day when Aval occurred)
		SD_dif2,3,4	2,3,4 days snow dept difference from the day when avalanche released; SDdif = SD_value - SD2,3,4
New snow sum [ <i>cm</i> ]	NSS	NSS_value	New snow fallen in a day
		NSS_value3	3 day moving average of new snow before avalanche release (day when Aval occurred)
		NSSsum3	Sum of 3 day new snow before avalanche release
Relative humidity [%]	H	H_value	Daily relative humidity
		H_value3	3 day moving average of relative humidity before avalanche release (day when Aval occurred)
Air temperature [ $^{\circ}C$ ]	Tair	Tair_value	Daily mean air temperature [ $^{\circ}C$ ]
		Tair_value3	3 day moving average of air temperature before avalanche release (day when Aval occurred)
		Tmin3	3 days minimum air temperature [ $^{\circ}C$ ]
		Tmax3	3 days maximum air temperature [ $^{\circ}C$ ]
		Tamp3	Thermal amplitude the day before and up to 3 days before the avalanche release [ $^{\circ}C$ ]; Tamp3 = Tmax3-Tmin3
Sunlight duration [ <i>hour</i> ]	SLd	SLd_value	Daily sun light duration
		SLd_value3	3 day moving sum of sunlight duration before avalanche release (day when Aval occurred)
Precipitation [ <i>mm</i> ]	P	P_value	Daily total precipitation
		P_value3	3 day moving sum of daily precipitation
Rainfall [ <i>mm</i> ]	Rain_Tw	Rain_Tw_value	Daily rainfall separated from total precipitation (P) based on single threshold (Tt = -0.5 $^{\circ}C$ ) wet bulb temperature (calculated according to Stull (2011) formula).
		Rain_Tw_value3	3 days moving average of Rain_Tw_value
Rainfall [ <i>mm</i> ]	Rain-Ta	Rain-Ta_value	Daily rainfall, separated from the total precipitation (P) based on single threshold air temperature (Tt = +0.46 $^{\circ}C$ ) Tt was calibrated by (Juras et al., 2021).
		Rain-Ta_value3	3 days moving average of Rain-Ta_value
		Rain-Ta_sum3	3 days sum of Rain-Ta_value prior the avalanche event
Wind speed [ <i>m/s</i> ]	Wsvg	Wsvg_value	Daily mean wind speed
		Wsvg_value3	3 day moving average of wind speed before avalanche release (day when Aval occurred)
Wind direction [ $^{\circ}$ ]	WD	WD_value	Daily circular mean of wind direction
		WD_value3	3 day moving circular average of wind direction before avalanche release (day when Aval occurred)



200 the set of the most relevant combination of explanatory variables for the avalanche occurrence represented as Ad and NAd in the model, and b) quantify how much important each variable is and test the model's performance.

A severely imbalanced dataset (91 / 271 of wet / slab Ad and 6588 / 6643 of NAd, respectively) makes the learning process difficult. Hence we created balanced datasets to enhance the skill of the model. We tried to balance the datasets by upscaling avalanche records and synthetic data generation; the latter method was more successful in evaluating model efficiency, hence we  
205 used the approach for RF - see further in Sect. 3.1.3 and 3.2.3. The former upscaled method was better for descriptive purposes and we used it only for one DT - see further in Sect. 3.1.2 and 3.2.2 The synthetic data generation method (Lunardon et al., 2014) overcame imbalances by generating artificial data via synthetic minority oversampling technique (SMOTE) (Chawla et al., 2002). A SMOTE algorithm creates artificial data based on feature space similarities from minority samples. It uses bootstrapping and k-nearest neighbour (KNN) algorithm and works as follows:

- 210
- KNN takes the difference between the feature vector (sample) under consideration and its nearest neighbour,
  - differences between neighbours are multiplied by a random number ranging from 0 to 1 (can be adjusted to maintain dispersion in data - our case),
  - new data are added to the feature vector under consideration.

Synthetic data had much higher dispersion than the original dataset (after application of aforementioned SMOTE approach);  
215 therefore, we generated data closer to our input data by adjusting the natural neighbour algorithm with Kernel density (ranging in our case from 0 to 0.5). Thanks to the SMOTE method, we can generate data with similar statistical distribution along with the two classes of avalanche types.

To check distributions of initial datasets of weather variables of original and synthetic data, we used boxplots divided by each variable, Quantile-quantile (Q-Q) probability plot (Loy et al., 2016), and PCA (Maćkiewicz and Ratajczak, 1993). Box plots  
220 of all variables are essential to understand the data for further modelling. By plotting quantiles of original and synthetic data against each other, we compared probability distributions. To see the distance of correlation variables we created dendrograms (Murtagh and Legendre, 2014). PCA reduces the dimensionality of datasets by creating components where standardized data are projected on the variable axis. PCA suggests the main differences in data for both datasets.

Prior to evaluation of the models, we split datasets into train (0.75) and test sets (0.25). For evaluation we used confusion  
225 matrix (CM), Receiver operating characteristic curve (ROC), and Area under the curve (AUC). CM makes a two way frequency table and compares predicted versus actual classes (Table A1). The ROC curve is the ratio of the sensitivity and specificity; by increasing one measure, the other is decreased. The AUC coefficient is defined as an area under the ROC curve and is a single-number summary of a model's predictability, ranging from 0 to 1; when  $AUC = 1$  it means that the model is correct all the time at predicting (James et al., 2013; Biecek and Burzykowski, 2021).

230 While we use the DT (Therneau and Atkinson, 2019) method to find out some variable threshold separating Ad and NAd, RF (Liaw and Wiener, 2002) is used to get the most significant variables of importance determining wet and slab avalanches. Whereas RF focuses on predictive performance, DTs present relationships in a way resembling to human decision-making

processes and are thus a helpful tool to understand the avalanche problem identification and assessment process (Horton et al., 2020).

235 The RF method was used to predict a binary target variable, specifically the occurrence of unique Ad and NAd, with multiple  
predictor variables; in this case, weather and snow variables. Generally, RF is robust to overfitting and yields an accurate, non-  
linear model due to bootstrapping observations from the bag which generates error rate: (OOB) and random pick of variables  
being compared at the moment of splitting data for classification. After training enough trees, stabilization the model's OOB  
error could be reached, gaining credible results. Hence we did not have to conduct cross validation to prevent overfitting. RF  
240 classifiers can improve prediction accuracy, however at the cost of interpretability (Sielenou et al., 2021). We obtained an  
overall summary of the importance of each predictor in the RF due to bagging. RF's benefit is that it can also perform feature  
importance of variables by conducting permutations on all the variables. Therefore we can distinguish what influence each  
of the variables has on the accuracy of the decision classifier process if we excluded a variable. A larger value of variable  
importance indicates a more important predictor (mean decrease of accuracy, MDA hereafter) (Gregorutti et al., 2017). To  
245 gain better performance of the RF, hyperparameters should be tuned. Hyperparameters impact model fit and vary from dataset  
to dataset (Probst et al., 2019). We picked the best parameters based on a grid search technique. A search grid is a set of  
hyperparameter combinations to be tuned for an algorithm and, by cross validating and re-evaluating the model, we found the  
best performing parameters based on AUC.

### 3 Results

250 This section presents statistical analyses of the avalanche datasets and relates meteorological and snow variables to wet and slab  
avalanches. Firstly, we show the trend analysis results of the avalanche activity in the study location. We investigate changes  
in wet and slab avalanches over the winter seasons (1962–2021). Second, we check the statistical distribution of datasets (see  
A.0.1) and assess the explanatory power of the weather variables concerning wet and slab avalanche activity using two methods  
- DT and RF. To highlight the potential effect of climate change on avalanche activity, we investigated the meteorological and  
255 snow variables trends for LBOU meteorological station.

In the Krkonoše Mountains, an average of 20 snow avalanches are reported each year. This number varies greatly year-to-  
year and ranges from 0–77 records (no record in winter 2011, 77 records in 2005). We focus on wet avalanches (185 records  
14.8 % of all snow avalanches in the Avalanche cadastre) and slab avalanches, the most frequent avalanches (826 records,  
66.3 %) in the Krkonoše mountain range. The percentages of avalanche activity are related to 1246 avalanches recorded over  
260 the period 1962–2021.

### 3.1 Wet snow avalanches

#### 3.1.1 Long-term wet avalanche activity in the study location

It was revealed that the number of wet avalanches classified in the cadastre as wet, i.e., C=2 (185 Aval), were increasing during the period 1962–2011. However, it has slightly decreased in the last decade, 2011–2021. The highest number of wet avalanches was observed in 2005. Over the last three decades there were about seven times more wet avalanches (163 total wet avalanches, annual mean = 5.6) than in 1961–1991 (22 total avalanche releases, annual mean = 0.7) (Fig. 2). The wet avalanche activity also changed within the winter season when we observe increases in avalanche occurrence in March, followed by February, in the last three decades (Fig. 3). Oppositely, decreases are observed in December, January, April and May.

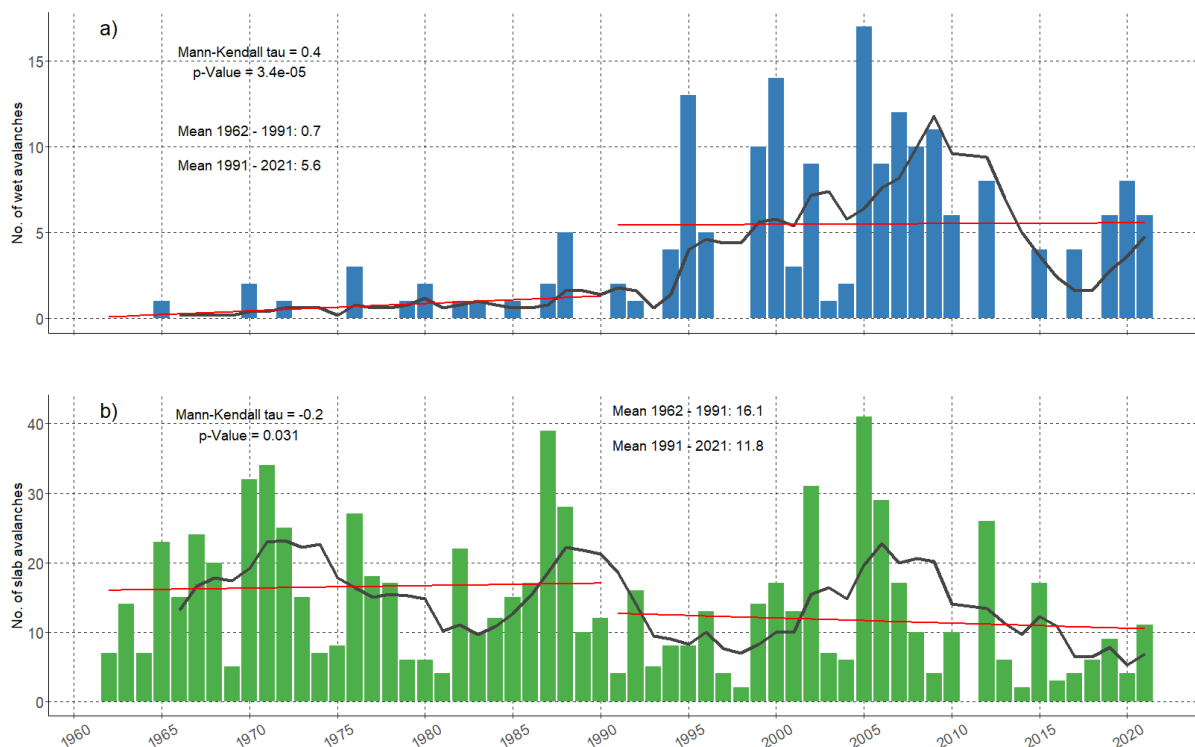

**Fig. 2.** Occurrence of wet and slab avalanches over the winter seasons 1962-2021. Each year represents the winter season (1.10–31.5). The trend was analysed by Mann-Kendall Tau, its significance was estimated by p value for two periods 1962-1991 and 1991-2021 (red line), and 5-season moving average (black line). The count of avalanches for each subperiod is calculated as a seasonal mean.

The avalanche length magnitude (size) denotes a moderate rise in proportional scale (0.2-0.4) and large and very large avalanches (> 0.8) from 1991 to 2021. More very large wet avalanches appeared during the period 1991–2021 in comparison with 1961-1991. We observe a rise in the number of wet snow avalanches in the last thirty years and a shift in the peak of avalanche releases towards earlier in the year, from mid of April to the beginning of April during the winter season (Fig. 3).

In general, wet avalanches mainly occur in March and April however, more wet avalanches releases are present in February in the last 30 years (Fig. 3).

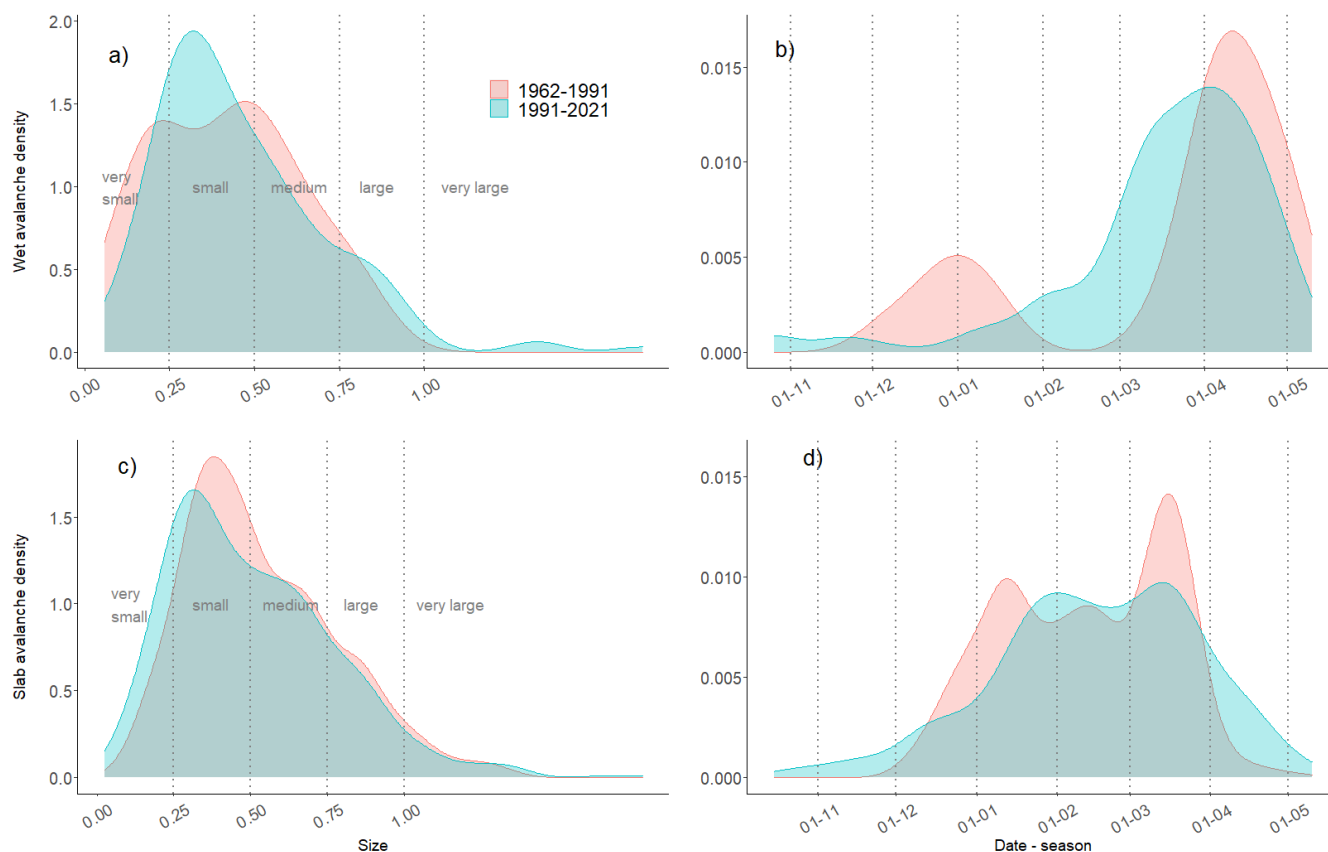
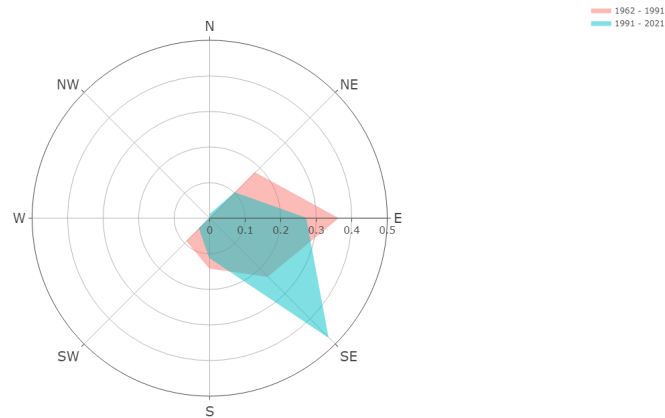

**Fig. 3.** Wet snow and slab avalanche characteristics splitted into two winter season periods 1962-1991 and 1991-2021. a) Proportional sizes of avalanche length related to the RAMMS 100 year return period output. b) Winter season distribution of avalanche occurrences.

275 The most wet avalanche releases were mostly frequented on eastern (E), south-eastern (SE), northeastern (NE), and south (S) respectively in the period 1961-1991. Whereas, in the last thirty years, the highest number of avalanches are on SE, E, S, and NE sides. The greatest change (24 %) in wet avalanche activity can be seen on the SE slopes. While the portion of wet avalanches increased from 23 % (1962 - 1991) to 47 % (1991 - 2021). On the other hand, the highest decrease (9 %) was observed on the E slopes, when the portion changed from 36 % (1962 - 1991) to 27 % (1991 - 2021) (Fig. 4).

### 280 3.1.2 Decision Tree of wet avalanches

We analyse weather variables determining triggering of wet and slab avalanches in the period 1979–2020. The wet avalanche dataset contains 91 unique wet snow avalanche days and slab avalanche dataset contains 271 avalanche days.



**Fig. 4.** The avalanche occurrence distribution per path orientation for wet snow avalanches. Radial axis represents the avalanche portion for each cardinal direction

The daily mean snow depth was the primary split in the decision tree of wet avalanches that splits days with and without slab avalanches (Fig. 5). The group of days with more than or equal to 99 cm had a probability ( $p = 0.38$ ) that an avalanche would occur. If 3-day moving average air temperature ( $T_{air\_value3} \geq -3.7$  °C) we obtained a 0.69 likelihood of avalanche (Aval) trigger, using 48 % of the observational data. If  $SD\_value3$  is higher than 177 cm there is a high probability of avalanche release ( $p = 0.79$ ). When  $SD\_value3 < 177$  cm is slightly above zero 3-day minimum air temperature is likely to trigger an avalanche ( $T_{min3} \geq 0.45$  °C,  $p = 0.68$ ). Other significant splits ( $p > 0.9$ ) are mean wind speed ( $WS\_avg\_value3 \geq 5.1$   $m \times s^{-1}$ ) and wind direction ( $WD\_avg\_value3 \geq 282$ ) (Fig. 5). The higher the snow depth, the higher the probability of avalanche trigger.

285  
290 This might be because of the fraction of wet snow compared to dry within the snowpack.

### 3.1.3 Meteorological and snow variables driving the wet avalanche activity using Random forest model and trend analysis

The random forest model ranked the most important variables based on Variable Importance (VIP) using MDA. The most important variables for wet avalanches seem to be 3-day maximum and minimum air temperature ( $T_{max3}$ ,  $T_{min3}$ ), snow depth ( $SD\_value3$ ,  $SD\_value$ ), wind speed ( $WS\_value$ ,  $WS_{avg\_value3}$ ), wind direction ( $WD\_value3$ ,  $WD\_value$ ), and rainfall based on by wet bulb temperature ( $Rain\_Tw\_value$ ) (Fig. 6). Sunlight duration ( $SLd\_value$ ) and precipitation are almost of 1.6 times less importance than 3-day maximum air temperature. From snow depth difference variables the most important is when it is 2 days different from avalanche day ( $SDdif2$ ) (Fig. 6). Wet bulb temperature is counted from humidity so humidity also plays role; however, its importance is 25. The wet avalanche model predicts 84 from 91 avalanches (92.3 %) and 6555 non-avalanches from 6588 (99.5 %). There were 33 false alarms wet snow avalanches (Fig. 11), which means that the model tends to falsely predict wet avalanches that are in real-world scenarionon-avalanches. We would falsely inform that there is a high probability of avalanche occurrence. The models perform well according to AUC criterium 0.992 (Fig. 11).

295  
300

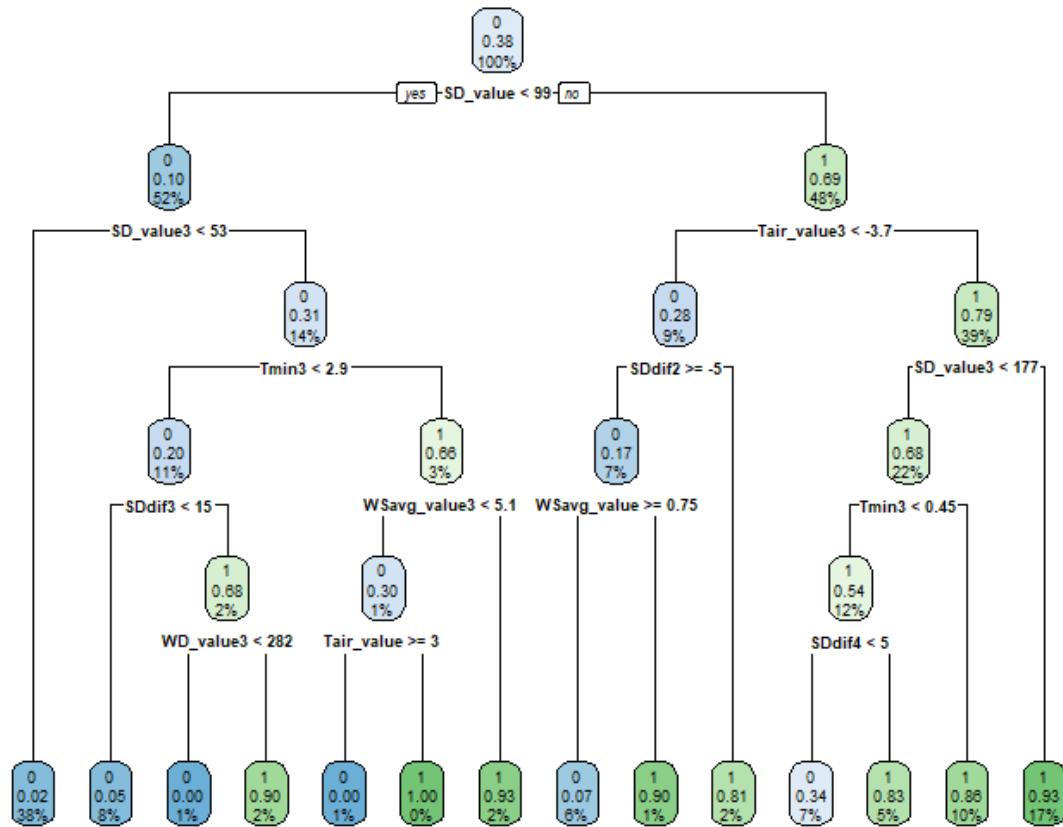

**Fig. 5.** The Decision Tree of weather variables triggering wet avalanches. Numbers 1 and 0 = avalanche day and non-avalanche day. The single value means the probability of occurrence/ non-occurrence of avalanche release. The percentage signifies how many percent of data is influenced by the split node from the wet SMOTE avalanche dataset.

From meteorological and snow variables, the wind speed was the variable with the most significant trend in both observed periods 1979–1999 and 2002–2020. In the recent period, precipitation (solid and liquid: P, Rain\_Tw, Rain-Ta) has shifted from a non-significant to a significant positive trend. Air temperature also has changed from non-significant to positively significant trends, and wind speed has changed to a negative trend. New snow was significant in the older period; however, not in recent 20 years Fig. 7.

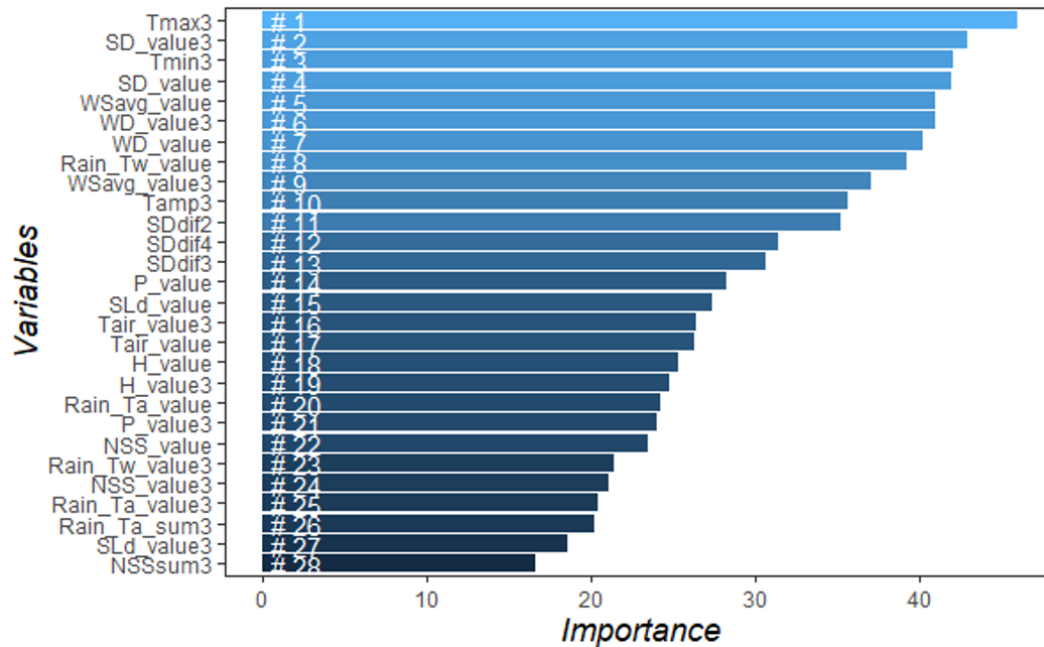

**Fig. 6.** Variable importance using the Mean Decrease Accuracy (MDA) for each variable of wet avalanche dataset (winter seasons 1979–2020) in the random forests. Variables are described in Table 1.

### 3.2 Slab avalanches

#### 3.2.1 Long-term slab avalanche activity in the study location

310 There might be a slight decreasing trend in slab avalanche records, (826 records) (483 total avalanche releases, annual mean =  
 60) in the 1961–1991, and 343 total avalanche releases (annual mean=43) in the last thirty years (Fig. 2). Mean value of slab  
 315 avalanches decreased from 16.1 (1961–1991) to 11.8 (1991–2021) significantly ( $p < 0.05$ ) by Wilcoxon non-parametric paired  
 test.

Avalanche size (small, medium, large, and very large 0.3-1.6 of proportional scale) has declined in the last thirty years in  
 315 comparison with the 1961-1990 period. Very small avalanches have risen in the last 30 years. Slab avalanches releases dominate  
 in March and mainly occur from December to April. In the last three decades, slab avalanches occur also in April which was  
 not that typical in the older period (Fig. 3).

The most of the slab avalanches releases were related to SE, E, S, SW slope in 1961-1991 period and SE, S, NE, E in the  
 last thirty years . In the last 30 years more slab avalanche release are present on NE sides. The greatest change (9 %) in slab  
 320 avalanche activity can be seen on the E slopes. While the portion of slab avalanches decreased from 23 % (1962 - 1991) to 14 %  
 (1991 - 2021). On the other hand, the highest increase (5 %) was observed on the SE and NE slopes, respectively. When the

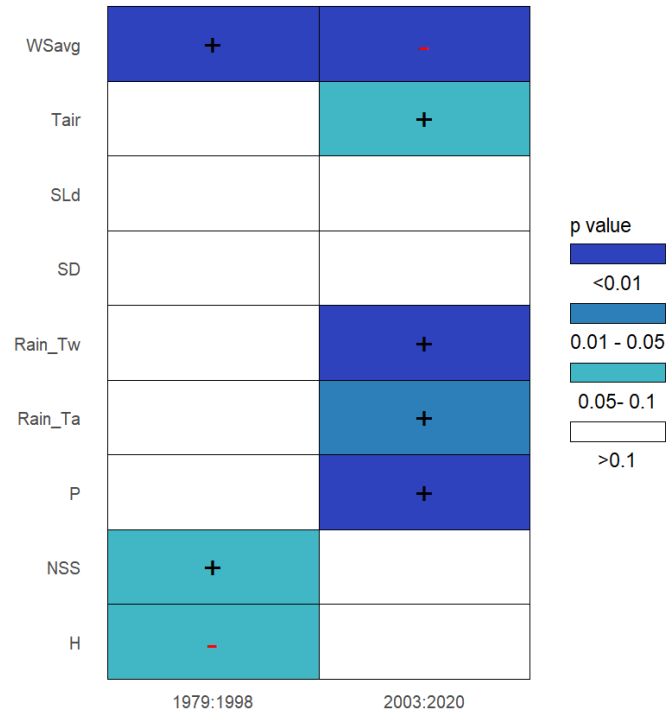

**Fig. 7.** Trends at LBOU meteorological station for meteorological and snow variables (mean values) in winter season (1.10-31.5). The values represent Theil-Sen's slopes. Significant Mann-Kendall trends are expressed by shades of blue ( $p < 0.01$ , dark blue), ( $p < 0.05$  medium blue) or ( $p < 0.1$ ), light blue. Increasing trend is displayed by "+", decreasing by "-".

portion changed from 32 % (1962 - 1991) to 37 % (1991-2021) and from 10 % (1962 - 1991) to 15 % (1991-2021) respectively (Fig. 8).

### 3.2.2 Decision Tree of slab avalanches

325 Snow depth was the primary split in the decision tree that splits days with and without slab avalanches (Fig. 9). In the group of days that had SD\_value more than 47 cm, there is a 0.36 probability that an avalanche will occur. However, if  $SD < 47$  cm, not releasing Aval is uncertain ( $p = 0.05$  - low value). The second split node (using 61 % of observation data) separates with 0.57 likelihood Ad and NAd. When 3-day mean new snow ( $NSS\_value3 \geq 3.8$  cm), an avalanche might occur ( $p = 0.77$ ), but when it is lower an avalanche is not likely released. The higher the 3-day mean snow depth SD\_value3 is ( $\geq 134$  and  $195$  cm),  
 330 the higher probability of avalanche release. If snow depth difference between four days before Aval record (SDdif4) is higher than 13 cm, the avalanche hazard increases. Avalanches occurs on aspects ( $WD\_value3 \geq 108^\circ$ ). Oppositely, do not release when wind speed is lower than  $11 m \times s^{-1}$  ( $p = 0.24$ ) and 3-day air temperature amplitude ( $Tamp3 < 6.6^\circ C$ ) in the Krkonoše Mountains.



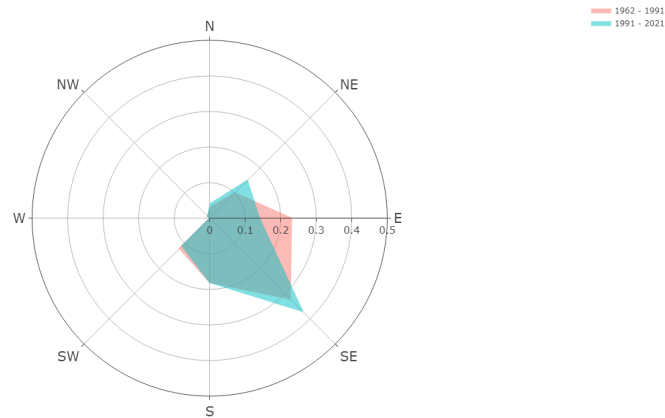

**Fig. 8.** The avalanche occurrence path distribution per orientation for slab avalanches. Radial axis represents the avalanche portion for each cardinal direction.

### 3.2.3 Meteorological and snow variables driving the slab avalanche activity using Random forest model and trend analysis

335

The most important variables for slab avalanches in the daily random forest are the most likely snow depth (SD\_value, SD\_value3), rainfall variables based on air temperature threshold (Rain-Ta\_sum3, Rain-Ta\_value, Rain-Ta\_value3), new snow (NSS\_value3, NSS\_value), wind speed (WSavg\_value3, WSavg\_value), and air temperature (Tair\_value). Daily mean air temperature was about 1.3 times less important than daily mean snow depth (Fig. 10). The results show that rain and snow related variables are more important than air temperature (Tair\_value). RF model correctly predicts slab avalanches 254 (true positives) / 271 (93.7 %) and 5813 (true negatives) / 6643 (87.5 %) slab avalanche days. There were 830 false alarms slab avalanche days (Fig. 11), which means that the model tends to falsely predict slab avalanches that did not happen in real-world scenario. The performance of the model according to AUC values is very good 0.97 for slab avalanches (Fig. 11). From meteorological and snow variables, snow depth is insignificant in both observed periods 1979–1998 and 2003–2020. In recent years, precipitation (solid and liquid: P, Rain\_Tw, Rain-Ta) and air temperature have had a significant positive trend, and wind speed has had a significant negative trend Fig. 7.

340

345

### 3.3 Changes in weather conditions influencing avalanche activity

Rising trend in wet avalanche occurrence over last four decades and slightly decreasing trend in slab avalanches is also accompanied by changing trends in meteorological variables. There is an apparent rising air temperature (1.8 °C), reduced wind speed (from 5 to 2.5 m/s), and slightly decreasing trend of max snow depth (from approximately 210 to 180 cm) the first decades in the 21st century, when there was an enormous number of avalanche releases in Krkonoše (Fig. 12).

350

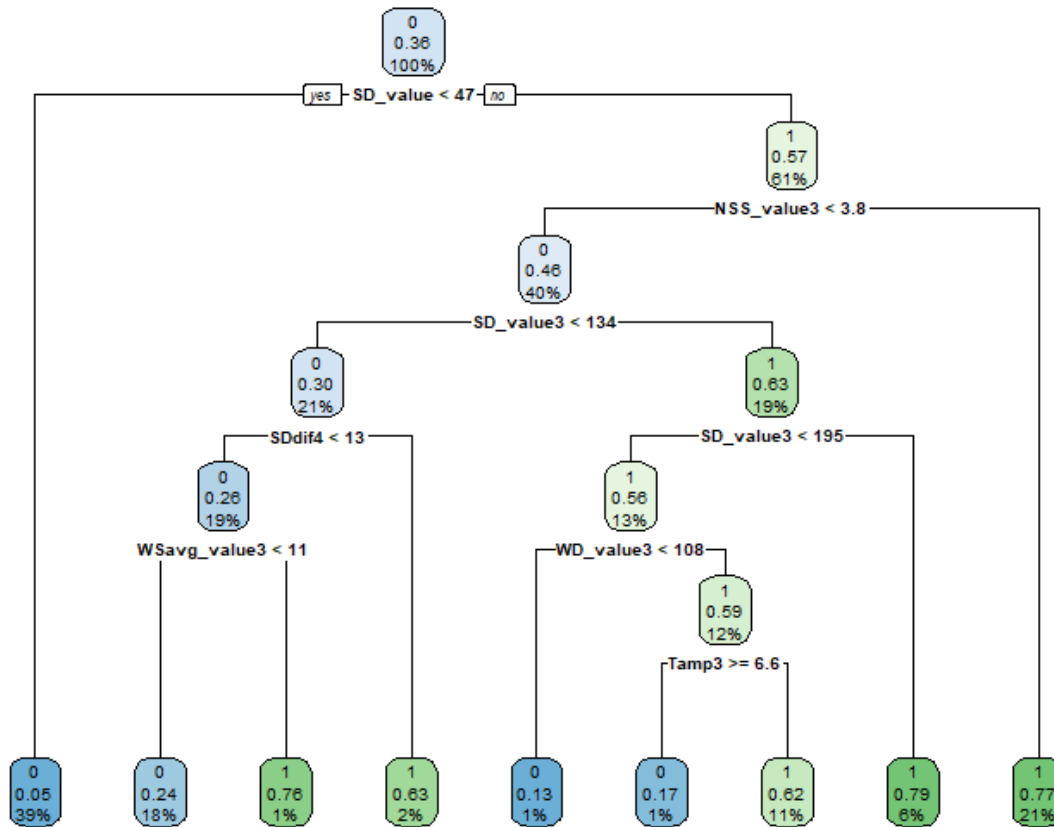

**Fig. 9.** The Decision Tree of weather variables triggering slab avalanches. Numbers 1 and 0 = avalanche day and non-avalanche day. The single value means the probability of occurrence/ non-occurrence of avalanche release. The percentage signifies how many percent of data is influenced by the split node from the wet SMOTE avalanche dataset.

#### 4 Discussion

Even though there is a lot of evidence of anthropogenic impacts on climate (e.g. Hock et al., 2019; Strapazzon et al., 2021), the effect of climate change on snow avalanches is poorly understood. Moreover, snow avalanche forecasting is still challenging (e.g. in Czechia, the avalanche forecasting model is missing). Therefore, in this work, machine learning aimed to determine the main meteorological and snow variables of wet and slab avalanche releases via the variable importance rating and their significance in low-altitude mountain range methods. This might help incorporate identified driving variables into avalanche warning decisions. We also performed trend analysis which might help to broaden the awareness of how warming will influence the type and number of avalanches.

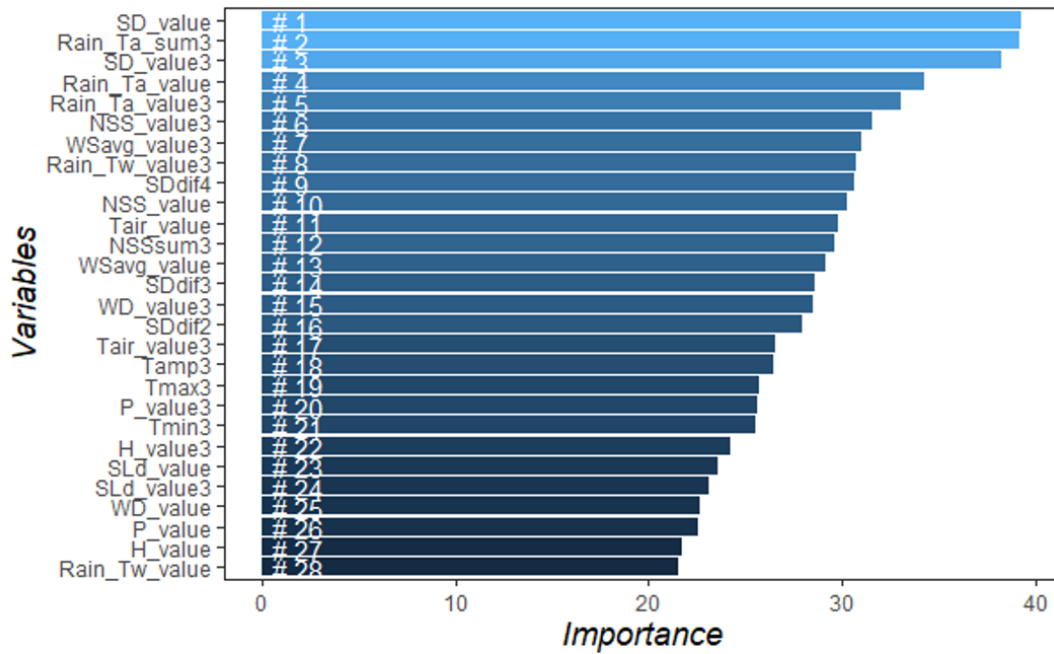

**Fig. 10.** Variable importance using the Mean Decrease Accuracy (MDA) for each variable of slab avalanche dataset in the random forests. Variables are described in Table 1.

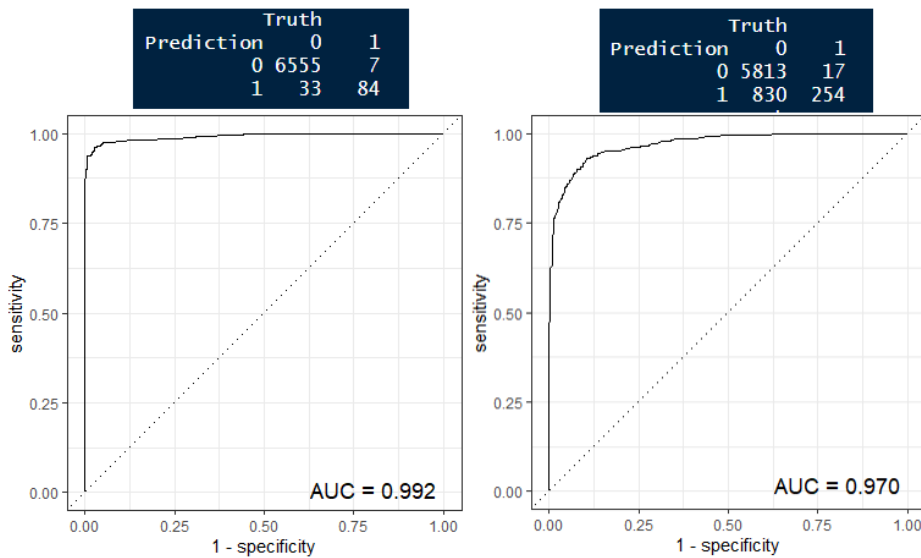

**Fig. 11.** Random forest model fit on original wet and slab avalanche datasets using CM, ROC, AUC metrics.

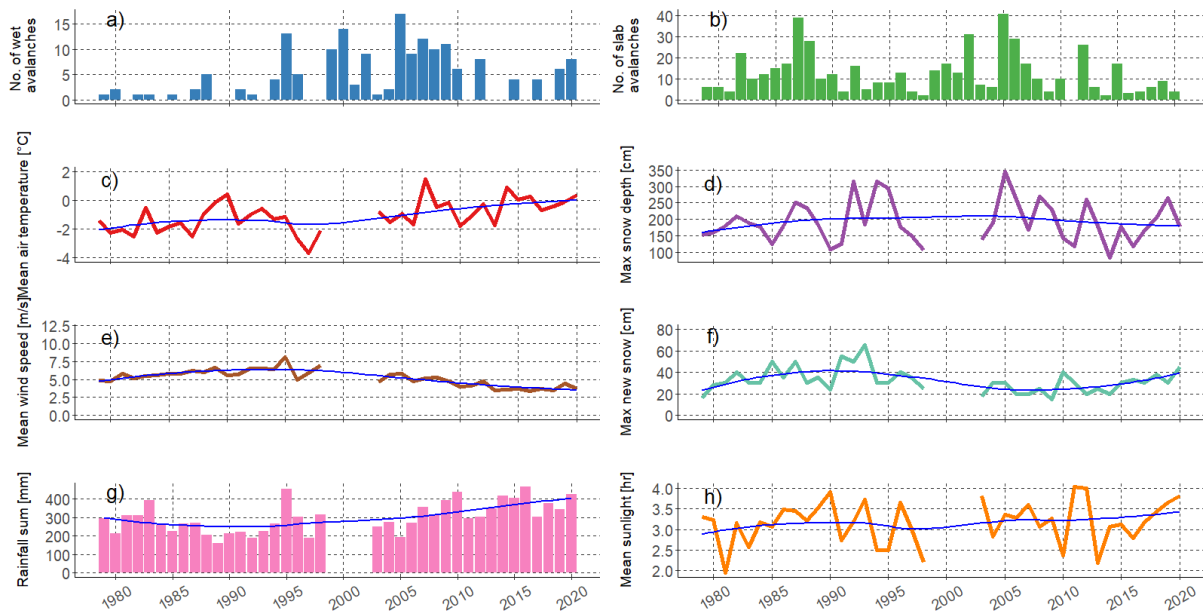

**Fig. 12.** Avalanche occurrence distribution and meteorological and snow variables conditions at Labská bouda automated weather station (1320 m a.s.l.) from 1979 to 2020. Horizontal axes represents winter season daily data aggregation from 1.10. to 31.5. The time series includes a data gap from winter seasons 1999–2002 for all weather variables. Blue line shows local polynomial regression for two compared period (1979-1998, 2003 - 2020). Air temperature, wind speed and sunlight subplots represent mean daily values over the given winter season.

#### 360 4.1 Wet Avalanches days determined by weather variables assessed by DT and RF method

Using the random forest method, we found that the most important triggering factors of wet avalanche activity are mainly: 3-day air minimum and maximum air temperature, 3-day moving average snow depth, and both 3-day mean wind direction and wind speed in the Krkonoše Mountains. As we expected, both wet and slab avalanches are dependent on snow depth. Moreover, rising trend in wet avalanches is presumably influenced by air temperature related variables (more likely maximum and minimum than mean air temperature) than liquid or solid precipitation (Rain\_Tw\_value, P\_value). Underlying physical process might be related to gradual weakening as snowpack becomes isothermal. Precipitation and sun light duration influence wet avalanches; however, from our RF results their contribution is almost twice lower than for air temperature in the Krkonoše Mountains (Fig. 6). The main variables possibly triggering wet avalanches are air temperature, snow depth, wind speed, and wind direction in RF and DT. Sunlight duration and rainfall (Rainfall\_Tw\_value) were important variables for RF however not in DT model (Fig. 6), (Fig. 5). Wet avalanches are determined by wind direction as wind usually redistributes snow. The dry warm wind, known as "föhn", can cause very intense melting or avalanches. On the Czech side of the Krkonoše Mountains, it arises when the wind blows from the north (from Poland).

## 4.2 Slab Avalanches days determined by weather variables assessed by DT and RF method

375 Slab avalanches are influenced by snow depth, rainfall related variables, new snow variables, and wind speed according to the RF method. Slab avalanches are most likely influenced by snow depth and triggered by rainfall (based on air temperature threshold), new snow, and wind speed (Fig. 10). Air temperature does play a role to some extent; however, daily mean air temperature was about 10 % less important than daily mean snow depth. From our results, it seems that rainfall has higher effect on slab avalanches than snow. Physically it could be related to overloading due to precipitation of partially weakened and wet snowpack.

380 Furthermore, both, wet and slab avalanches are influenced by wind speed; this might be caused by the LBOU meteorological station position. Around the station there are open plains of level surfaces, which accelerate the prevailing westerly winds. Afterwards, the wind falls into the deep cirques behind the plains (Obří důl, Labský důl) (Součková et al., 2022), causing massive air turbulence which influences snow conditions of avalanche paths. Wind usually redistributes new snow, so new snow might be a less significant variable for slab avalanches which seems to be case of our data in the Krkonoše Mountains  
385 Daily mean snow depth (SD\_value) was the most important variable in the random forest for predicting slab avalanches, and it was the primary split for decision trees. DT and RF are in accord in most of the RF importance variables higher than 25 MDA (Fig. 10), (Fig. 9) except for rainfall variables (Rain\_Ta\_value, Rainfall\_Ta\_value3, Rainfall\_sum3).

## 4.3 Model performance: Random forest as a relevant machine learning method for avalanche activity

Our models show interesting forecasting potential. Random forest is a relevant method for targeting either avalanche days or  
390 non-avalanche days of wet and slab avalanche activity according to metrics used for our datasets, assessing performance of the model: very low error rate and high accuracy of prediction of wet and slab avalanche dataset. We checked the RF models skill against the original dataset and we achieved satisfactory results for model metrics (Fig. 11) in the Krkonoše Mountains. RF selection as a relevant method ties well with the previous study of Sielenou et al. (2021).

## 4.4 Avalanche characteristics and related weather variables

395 As within the alpine environment, more road accidents happen due to avalanche fencing, so attention was paid to changes in the flow characteristics, such as the formation of shorter and less predictable runouts (Eckert et al., 2013; Naaim et al., 2016). Moreover, it is becoming more common that very large avalanches which originally release in dry snow drag along warm snow in the avalanche path below (Eckert et al., 2013; Naaim et al., 2016; Sielenou et al., 2021). This is consistent with medium confidence in an increase in avalanche activity involving wet snow, and a decrease in the size and runout distance of snow  
400 avalanches over recent decades, particularly in Europe (Hock et al., 2019). This is confirmed by our results of the accelerated increase of wet avalanche occurrences for the last 30 years (7 times more avalanches than in the previous 30 year period) (Fig. 2). According to Naaim et al. (2016), wet avalanches occur more frequently, even in winter from December through February. In contrast, we have not found an increasing number of wet avalanches in December. However, in January and mostly in February, there are more occurrences in the last three decades than there were in the rest of the studied period. Slab

405 medium (0.4–0.5) avalanche sizes have slightly decreased and small sizes have increased in 1991–2021 period. Interestingly, few very large avalanches are present (see Fig. 3). Possibly because of gradual overloading by precipitation and wind or gradual weakening and warming of snowpack.

Our RF data indicate that wet avalanches in the Krkonoše Mountains are more related to increasing air temperature causing snowmelt rather than rainfall. Furthermore, the RF model (see Fig. 6) also shows rising temperature during the last two decades  
410 (about 1.8 °C), which is depicted in Fig. 2 and is significant variable from 2002 to 2020 Fig. 7. Total precipitation (P), and thus rainfall (Rain\_Tw, Rain-Ta), have also increased over the last two decades significantly with positive trend Fig. 7. Rising temperature in the study region was also documented by Kliegrová and Kašičková (2019). Snowmelt is, beside temperature, also driven by solar radiation or wind speed; our results show slightly increasing total sunlight duration since 21th century, however the trend is not significant. Wind speed is usually considered as an important driver governing turbulent heat exchange be-  
415 tween snowpack and atmosphere, however it seems that wind speed has slightly decreased in the Krkonoše Mountains over the recent snow seasons significantly (Fig. 7). Similar decreasing wind speed trends were observed by Zahradníček et al. (2019) suggesting that biased wind speed measurements could be linked to changes e.g., in roughness in the surroundings, and instruments type. The decreasing trend in wind speed probably affects snow deposition, snowmelt, and thus wet and slab avalanche activity. Moreover, air temperature or rain prevalence is probably elevation-based. According to Nedelcev and Jeníček (2021)  
420 it seems that, snowpack is more sensitive to changes in air temperature at elevations below 1200 m a.s.l. and precipitation at elevations above 1200 m a.s.l. is common in Czechia mountain catchments. Moreover, Baggi and Schweizer (2009) related wet snow avalanches to precipitation within the Eastern Swiss Alps and weather data at an elevation of 2300 m a.s.l., and they propose that wet instability is strongly influenced by snowpack properties related to the warming of snowpack and meltwater production. Our results confirm the finding of Laute and Beylich (2018) that the probability of wet snow avalanches increase  
425 due to more frequent periods with air temperatures close to or above freezing point during the winter period in the last two decades (Fig. 2). Peitzsch et al. (2012) emphasize the variable importance on air temperature and more on snowpack settlement and snow water equivalent loss, explaining wet slab avalanches in Glacier National Park, Montana, USA.

Avalanche activity of north easterly oriented avalanche release zones in the Eastern Swiss Alps was primarily related to snow depth, precipitation, and air temperature (Baggi and Schweizer, 2009). This finding is in line with our study; however, for  
430 Krkonoše leeward S-SE, E oriented release zones, wind direction and wind speed influence snow deposition and thus avalanche activity. Mainieri et al. (2020) observed a contrasting pattern on northern and southern avalanche paths due to land cover changes (afforestation, deforestation) and socio-environmental changes. Whereas frequency on southern paths increased sharply in the 1970th, in Krkonoše mountains wet avalanches were occurring in SE, E, S expositions in the last 30 years (1991-2021) without the influence of significant land cover changes in avalanche release zones due to limited forestry clear cuts and forest  
435 burn out as they are located in the first and second zone of KRNAP. Although the other parts of KRNAP undergo LC changes Janík et al. (2020). Baggi and Schweizer (2009) revealed that wet-snow slab avalanche days (primarily observed in May) were significantly ( $p < 0.05$ ) related to several variables including minimum air temperature, the sum of positive air temperatures of 3 or 5 days, rain, and decrease in snow depth over 3 days. In a non-European environment, Bridger Bowl (SW Montana) days with deep slab avalanches on persistent weak layers often had warmer air temperatures for a minimum of 24 hours (days were

440 typically preceded by 3 days above freezing), and more precipitation over the prior 7 days, than days without deep slabs on  
persistent weak layers (Marienthal et al., 2015). The variables are equivalent to our results, see Fig. 10. Conversely, in areas  
above 2100 m a.s.l., snowfall in the past 72 hours was the most significant variable for storm slab avalanche problems, and  
slab density was the most crucial variable for persistent-slab avalanche problems in Glacier National Park, Canada (Horton  
et al., 2020). In the High Arctic landscape around Svalbard's main settlement of Longyearbyen (78 ° N), precipitation and  
445 snowdrift 24, 48, and 72 hours prior to an avalanche and non-avalanche day were the best predictors of avalanche activity,  
and min, max, and mean wind speeds could be used as indicators of avalanche activity (Eckerstorfer and Christiansen, 2011).  
Contrary to our findings and those of Baggi and Schweizer (2009), Eckerstorfer and Christiansen (2011) did not find any  
significance of air temperature. According to Germain et al. (2009), wind is an important snow transport agent governing  
avalanche activity; wind largely controls avalanche activity in a barren landscape. Thus it is not necessary for large amounts  
450 of snowfall to release avalanches as the wind can redistribute the snow quite efficiently, limited by the availability of snow  
(Eckerstorfer and Christiansen, 2011). In our results, a combination of barren plateaus at the top of the Krkonoše mountains is  
present and could explain less importance of new snow in triggering slab avalanches.

Existing studies focusing on weather conditions triggering snow avalanche release show somewhat contradictory results.  
It is difficult to relate results and trends of snow avalanche activity to climatic fluctuations due to various environmental  
455 factors that control snow avalanche activity (Laute and Beylich, 2018). We claim and have reviewed that the results vary with  
many geographic characteristics, such as location (latitude, longitude), elevation (Giacona et al., 2021; Sielenou et al., 2021),  
type of climate (maritime, continental), local-to-regional topography, position of station: leeward/forward side, scale (small:  
specific roads sections/regional), and avalanche type definitions. So far, only a limited number of studies exist with weather  
or snowpack data from different elevations relevant to snow avalanche formation (Laute and Beylich, 2018; Sielenou et al.,  
460 2021).

The separate climatic, snow, and avalanche releases in Krkonoše were described in Spusta et al. (2020) during winters  
2006/07–2018/19; however, the relationship between the individual daily meteorological snow conditions related to avalanches  
has not yet been done in Czechia. With the Man-Kendall trend test, we validated and investigated how our results relate to  
climate change, and expressed the size of the change with Sen's slope. This method was also used for snow and climate char-  
465 acteristics trends investigated for different czech mountain catchments by Nedelcev and Jeníček (2021). To get a long-term  
avalanche dataset methods enabling climatic reconstructions like tree rings and historical archives (paleoclimate data) may be  
used (Corona et al., 2013; García-Hernández et al., 2017; Giacona et al., 2018; Mainieri et al., 2020; Peitzsch et al., 2021;  
Giacona et al., 2021; Germain et al., 2022)

## 4.5 Limitations

### 470 4.5.1 Related to the avalanche database

Some uncertainty of the quality of the avalanche survey regarding unfavoured weather conditions related to the occurrence  
date may exist. More specifically, during stormy weather, the avalanches may not have been recorded on the day when it

was released or the avalanche type might have been misclassified. Therein data undergoes quality assurance and assessment by avalanche observers. Furthermore, we also have detailed information about separate avalanche records and meteorological and weather parameters for each winter from 2006/2007 to 2018/2019 in (Spusta et al., 2020), and from the winter 1962 to 2006, the written description of monthly/winter period weather conditions are available in avalanche cadastres (Vrba and Spusta, 1975, 1991; Spusta and Kociánová, 1998; Spusta et al., 2003, 2006). Regarding the validity of the observations in time, sophisticated techniques, including drone and camera photos, were unavailable at the beginning of avalanche records. The avalanche-prone area was frequently monitored in person, and avalanche occurrences were validated with weather data by the avalanche support staff of the Krkonoše Mountain Rescue service. Regarding the length of avalanche data, we consider our avalanche dataset length as unique for low altitude mountain range as it contains 59 winter seasons, moreover data are available and have compact sources. Although the fact that the studies by (Giacona et al., 2018, 2021; Peitzsch et al., 2021) enable inferences of longer-term changes of avalanche activity thanks to dendrochronology method using tree-ring reconstruction since 19th century or even 18th century (Mainieri et al., 2020), their data were generated not only from professional sources, but also from written and oral sources (newspapers, old postcards, local non-scientific literature) so they might be prone to errors. Furthermore they have to tackle non-stationarities resulting from forest recolonization, afforestation or related to socio-environmental changes.

It is worth to mention that wet and slab avalanche dataset intersects. While slab avalanches are defined according to criteria, zone of origin (known as release zone), a) manner of starting, the wet avalanches are defined by b) liquid water in snow according to Quervain et al. (1973) Avalanche classification. Wet and slab avalanche datasets have 53 avalanche days with the same weather conditions within the inner join. This fact makes their model results similar to some extent and explains analogous Variable Importance of RF plots.

#### 4.5.2 Related to the weather variable

The LBOU weather station used in this study is located approximately 0.2–15 km away from the closest (27) and furthest (01) avalanche path in the west and east Krkonoše (Fig. 1). On the one hand, it is the only station used for the analysis, on the other hand, one professional weather station for such an area extent and data series length is usual in a mountain environment. In choosing a relevant meteorological station according to data availability, the location position of the station was the only option. Other meteorological stations: have short time series (like Luční bouda (LUCB, 1413 m a.s.l., data since 2009)), Vítkovice (VITK, 1410 m a.s.l.) station was replaced by LBOU station, or they are located further away as Harrachov (HARR, 675 m a.s.l.). In case we had chosen other stations, the ranges of identified variables may have differed, and therefore the interpretation may change, but this does not necessarily invalidate the models (Gauthier et al., 2017). The results might be partly site specific. When interpreting the data we should be aware of the prevailing aspects of the avalanches release areas. Actual values of weather conditions at LBOU station on windward open plain may slightly differ from weather conditions at avalanche paths on mostly lee-ward positions (Fig. 4),(Fig. 8).

LBOU bouda station has a data gap from 1-10-1999 till the end of September 2001 when the station was not operating and measuring sensors were replaced.



### 4.5.3 Related to the modeling processes used: Decision trees and Random Forest models

Decision trees are suitable means for descriptive purposes, as a decision support systems or reflection of a process. Overfitting is one of the practical difficulties for decision tree models. It happens when the learning algorithm continues developing hypotheses that reduce the training set error but at the cost of increasing test set error. Decision trees cannot be used well with continuous numerical variables. A small change in the data tends to cause a considerable differences in the tree structure, which causes instability.

RF model using synthetic data might present a good starting point for obtaining a feasible system to complement decision support in estimating snow avalanche hazard Sielenou et al. (2021). However, the variables with best importance differ with length of the explored data series. Therefore, every year, models should be re-run using data from the most recent season to ensure optimal performance of the RF method, which is in accord with the claim of Gauthier et al. (2017). Inferring physical processes that drive avalanche activity can be challenging, as these statistical methods are reliant on correlations that do not necessarily represent causal links (Sielenou et al., 2021). Since the focus of the analysis was to explore relationships rather than construct predictive models, further enhancing the model's performance is beyond this study. However, another step to get more precise predicting model could be gradient boosting or neural network. Removal of variables with low importance could also result in better RF performance.

Another limitation might be that the RF/DT analysis is stationary, i.e. the effect of the drivers does not change in time (the models were fit to the whole period and non-stationarity is not considered. The number of Ad is relatively low and additional data are needed.

The estimated importance of variables often changes with the different models (Gauthier et al., 2017) and, based on our experience and that of Sielenou et al. (2021) with statistical methods and machine learning methods (random forest, logistic regression, classification tree), length of the examined period. We suggest that the skills of the model have to be evaluated by metrics, such as confusion matrix, since we can distinguish between the false and positives rates of predictions which was missing in some studies (e.g. Baggi and Schweizer, 2009; Eckerstorfer and Christiansen, 2011; Dreier et al., 2016). These metrics provide an assessment of potential forecast reliability.

### 4.6 Recommendations at various scales

For assessing the danger of avalanches, worldwide avalanche services could use, amongst others, meteorological data measured daily and expert knowledge about avalanche activity (Gauthier et al., 2017; Sielenou et al., 2021). Czech avalanche safety currently uses expert knowledge; therefore, avalanche prevention might start using machine learning to get additional insights leading to better decision-making processes for an avalanche warning system. The weather and snowpack variables offer a snow science perspective on what conditions favoured the formation of different avalanche types. Finer temporal and spatial scale such as hourly data or gridded data or closer positions of weather stations related to avalanche paths may improve insights into what meteorological conditions drive avalanche characteristics.

Our data implies that there will be more wet avalanches in terms of avalanche type. Regarding the size, results could point out that larger avalanche sizes release because of rising air temperature and shifted precipitation earlier in winter. Perhaps, there is a potential rise in large-magnitude occurrences associated with warmer temperatures and spring precipitation than only linking the large-magnitude avalanches to winters with thick snowpacks (Peitzsch et al., 2021). People visiting Krkonoše in winter should know the possibility of larger-scale wet slab avalanches. Although we studied wet and slab snow avalanches, our approach might be extended to different avalanche types, avalanche return periods or extended avalanche danger rating as mentioned by Sielenou et al. (2021) rather than broader studies just looking at the differences between avalanches and non-avalanches. However, unification and using the same avalanche type and size definition (within diverse avalanche classification) would help to compare results from different regions. Sielenou et al. (2021) suggest that avalanche activity could be separated according to elevation range, aspect, or slope.

As Germain et al. (2005) showed, tree removal—following clear-cuts and forest fires affect snow redistribution, which would increase the frequency of events in both existing and new avalanche paths. Forest management services should always carefully consider where deforestation and landscape heterogeneity apply. Deforestation in release areas of Krkonoše mountains is partly restricted or limited due to its location within the first and second KRNAP zones. However, for example, the 16A, B (Součková et al., 2022), (Fig. 1) avalanche paths were deforestrated, and the ski-touring route intersects the avalanche path; thus the avalanche danger arises. As the meteorological stations are scarcely distributed over the mountain regions, and satellite snow data still does not reach a high resolution, Cosmic-Ray Neutron Sensors (probes) could fill the gap in terms of time and spatial scale of snow water equivalent (Schattan et al., 2017; Bogena et al., 2020). Another scope of studies could relate snow and weather profile properties to concrete avalanche sector releases. Recently, the snow profiles have been recorded by Krkonoše Mountain Rescue (since winter 2006) in the Krkonoše mountains. When the avalanche observers are not sure about the exact date of the release, they should more carefully record the avalanche, not assign the date, and put a proper note of uncertainty. Also, carefully distinguish between avalanche release and sluff in the avalanche cadastre.

## 5 Conclusions

We investigated the long-term regime of the avalanche dataset and weather variables related to the avalanche activity. Due to climate change, more avalanches involving wet snow (defined as C2 in (Quervain et al., 1973)) due to snowmelt and decreasing trend of slab avalanche occurrence (the most dangerous type of avalanches for off piste skiers and tourists (Schweizer and Föhn, 1996)) have been recorded in mid-elevations of the Krkonoše Mountains, north-east Czechia. We applied the random forest method to quantitatively explain the importance of the meteorological and snow variables of wet and slab avalanche types. We used 28 predictors to feed the random forest model. Predictor selection, hyperparameters tuning was performed and RF model yielded high performance. The most important variables for wet avalanches were 3-day maximum and minimum air temperature, snow depth, wind speed, wind direction, and rainfall based on wet bulb temperature. This results is in accordance with increasing winter season air temperature (1.8 °C) since 1979. The most critical variables explaining slab avalanche activity were snow depth, rainfall variables based on threshold temperature, new snow, and wind speed. Air temperature also plays

a role; however, rain and snow-related variables are more important variables for slab avalanches than air temperature for the period 1979–2020. Our results might provide vital information for avalanche forecasting, and public authorities could use them, such as the Krkonoše National Park administration, the mountain rescue services of Czechia, or the Institute of Forest Management. Land use management practitioners should adapt their behavior and planned management activities to simultaneously mitigate avalanche hazards and conserve unique ecosystems (requiring avalanche releases in Krkonoše National Park). The methodology has the power to identify driving weather variables of wet and slab avalanches. We recommend a combination of expert knowledge about avalanche activity, snow profile measuring (stability tests and snowpack meteorological conditions), and the identified daily, hourly where available meteorological and snow variables to assess the avalanche hazard.

580 *Code and data availability.* Meteorological daily data for the case study are freely available and can be found at the Czech Meteorological Institute (CHMI) website: <https://www.chmi.cz/historicka-data/pocasi/denni-data/Denni-data-dle-z.-123-1998-Sb>. The original avalanche dataset was provided for research purposes by the owner Valerián Spusta and Valerián Spusta Jr. (permission of the owner is required). Input datasets for R outputs and markdown codes for machine learning are available at Zenodo (Součková et al., 2022).

*Author contributions.* MS: Conceptualization, Methodology, Formal analysis, Writing – original draft, Visualization. RJ: Formal analysis, Methodology, Writing - review editing. KD: Formal analysis, Methodology, Software, Writing - review editing, Validation. VM: Formal analysis, Writing - review editing, Validation. JRB: Formal analysis, Methodology, Writing - review editing, Validation. MH: Supervision, Conceptualization, Methodology, Writing - review editing, Validation.

*Competing interests.* The authors declare that they have no conflict of interest.

## **Acknowledgements**

590 We would like to thank and are grateful to Valerián Spusta and Valerián Spusta Jr. for providing us the Avalanche dataset and for the effort to collect and describe avalanche records. Jan Blahůt for providing us RAMMS avalanche path lengths and to Krkonoše National Park administration. The project was supported by IGA Faculty of Environmental Sciences CULS Prague “Avalanche hazard in the Krkonoše mountains and refinement of snow data collection methods, – No. 2020B006” and “Analysis of the properties of artificial snow and prediction of environmental impacts at the artificial snowmaking site - No. 595 2021B0029”.

# Appendices

## A.0.1 Exploratory datasets analysis of original and synthetic data

Initial dataset distributions of weather variables of original and synthetic data show similar distributions of box plots of wet (Fig. A3) and slab avalanche (Fig. A4) datasets. Although some distortion can be found in the Q-Q plots, the most significant parts overlap in the wet (Fig. A5) and slab (Fig. A6) avalanche dataset. PCA of Ad and NAd suggests the main differences in data for both datasets of wet (Fig. A7) and slab (Fig. A8) avalanches.

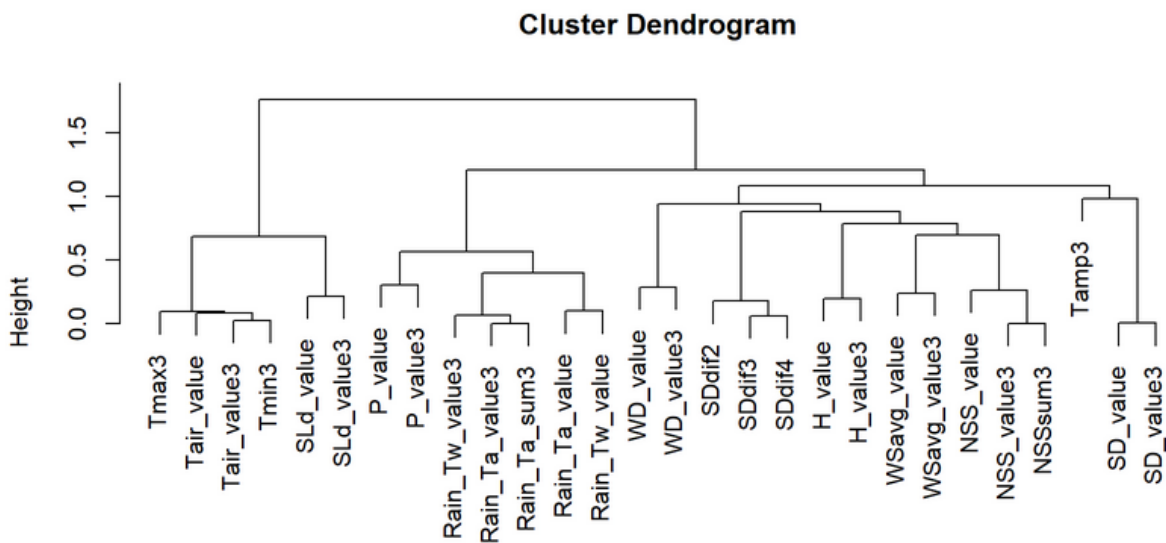

**Fig. A1.** Dendrograms of covariate variables of wet avalanches.

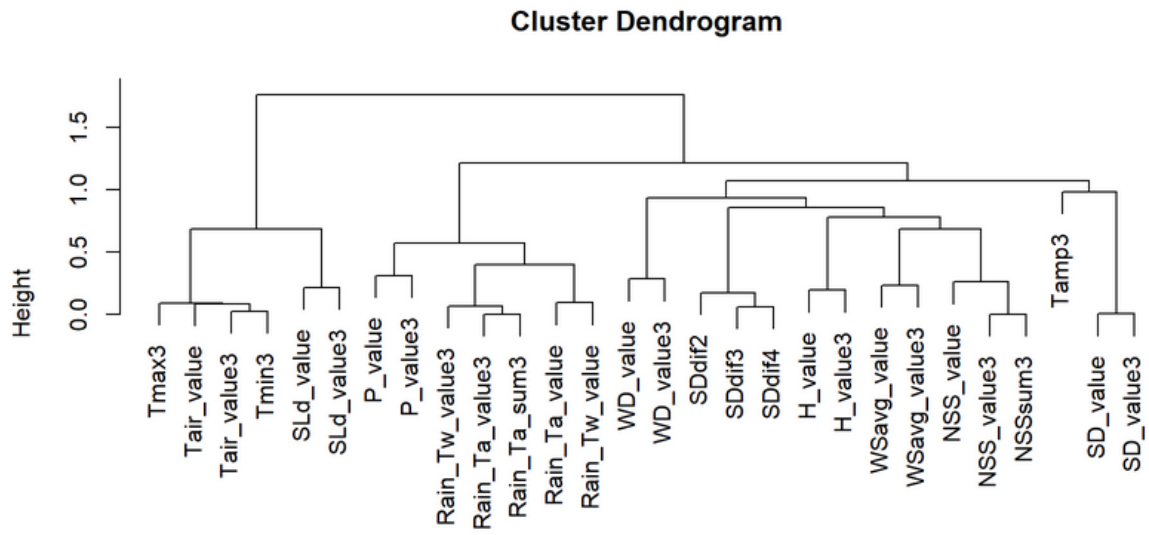

**Fig. A2.** Dendrograms of covariate variables of slab avalanches.

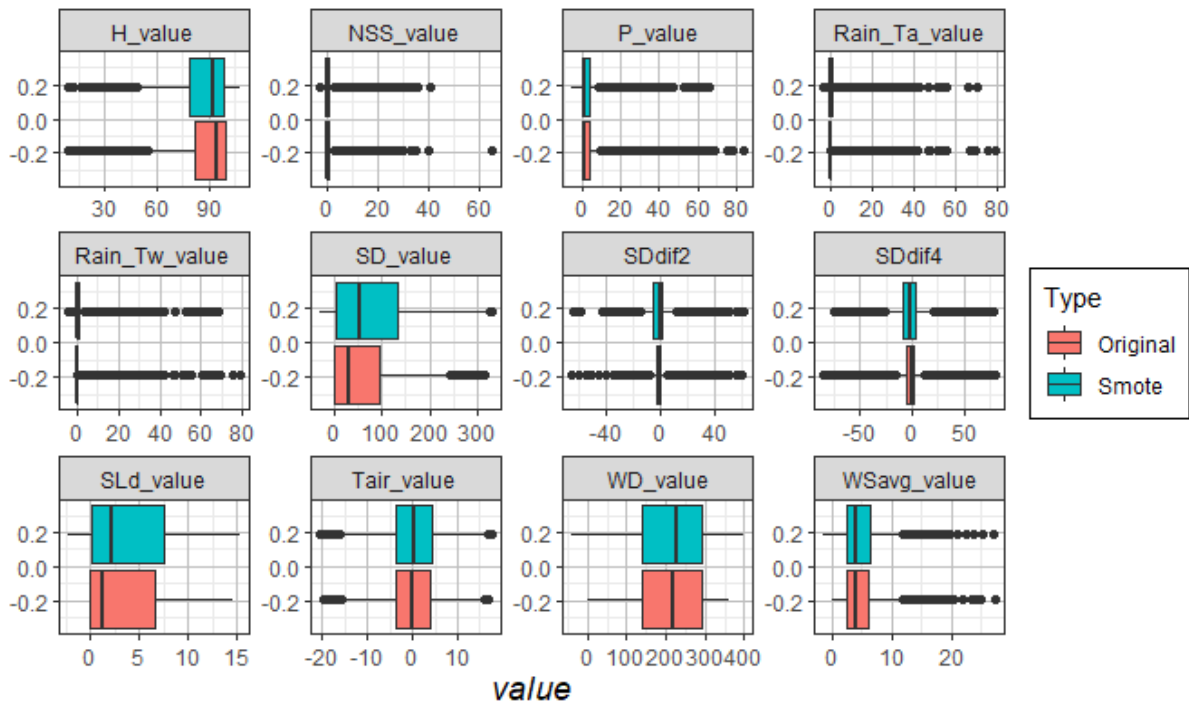

**Fig. A3.** Boxplot of wet avalanches of original and synthetic (Smote) data.

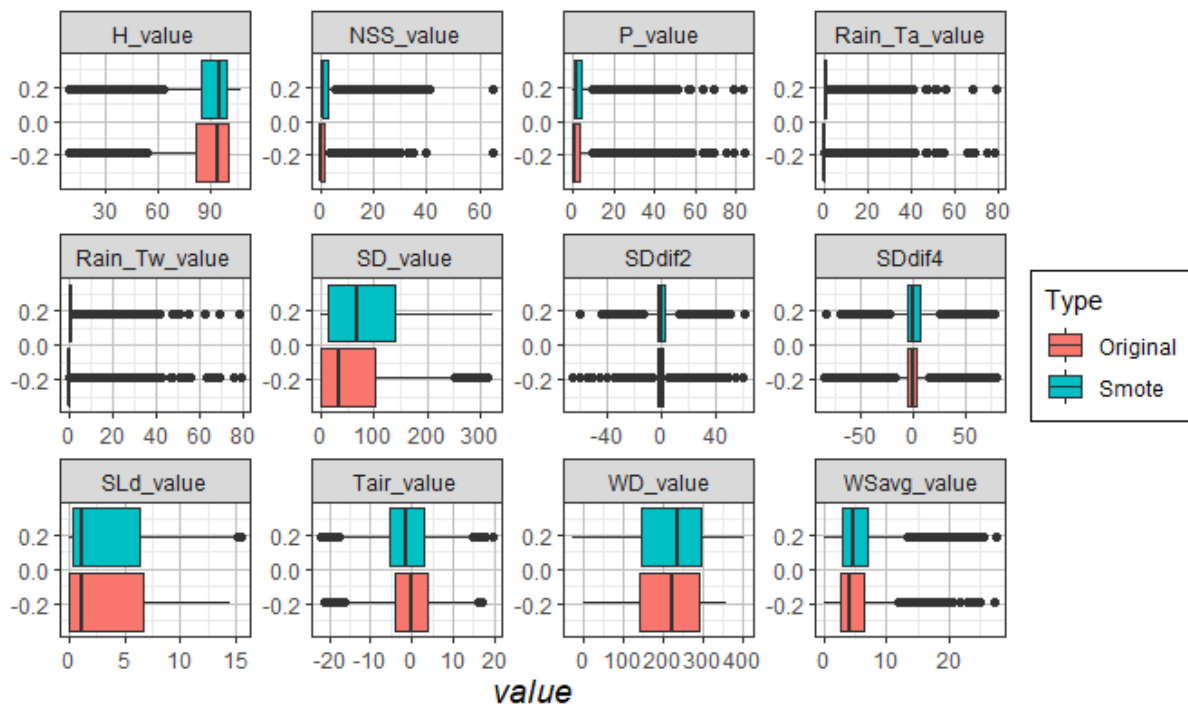

**Fig. A4.** Boxplot of slab avalanches of original and synthetic (Smote) data.

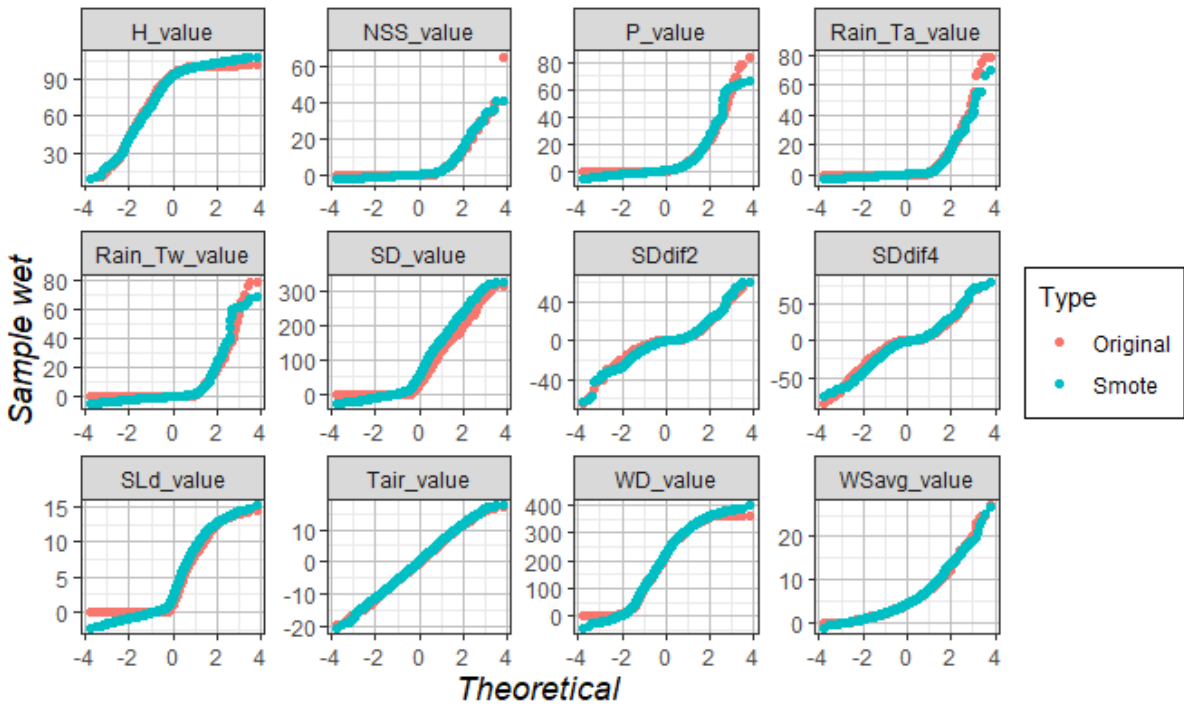

Fig. A5. Quartile-quartile (QQ) of wet avalanches of original and synthetic data (Smote).

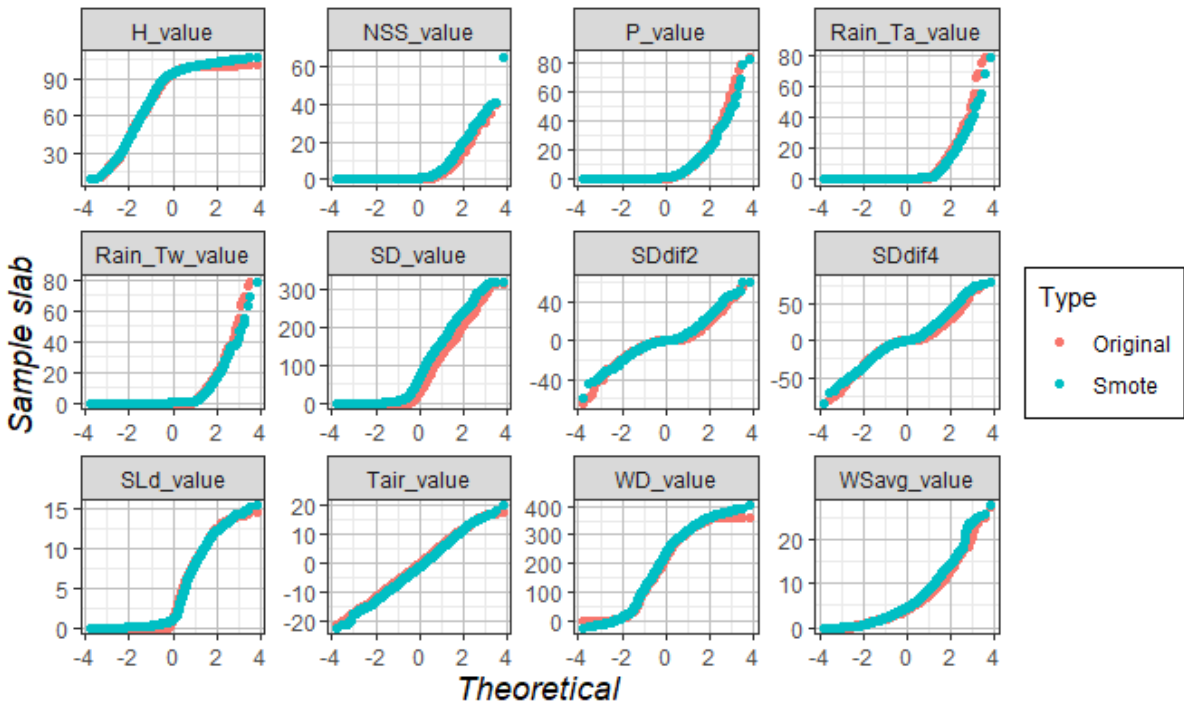
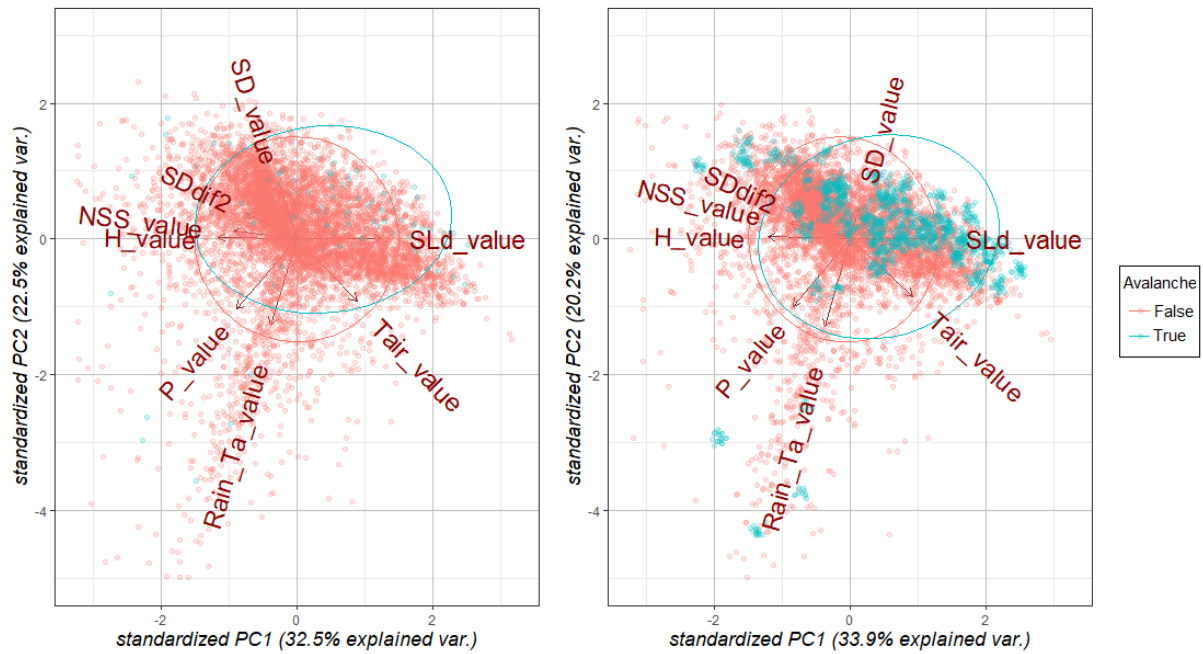
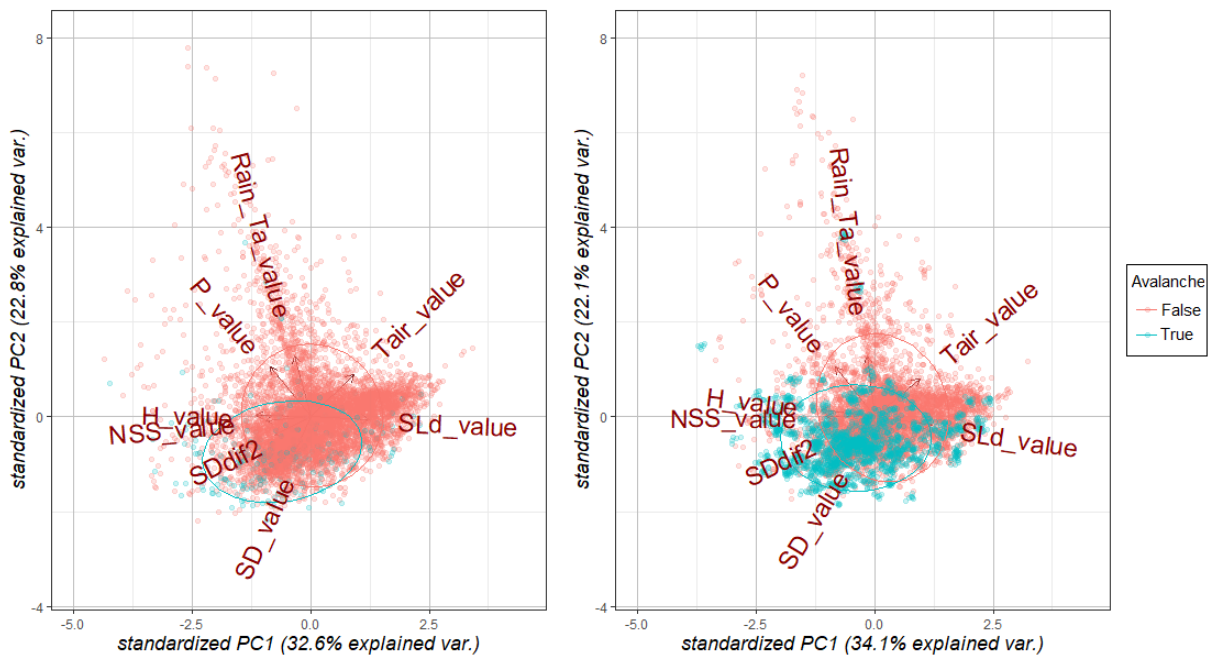

Fig. A6. Quartile-quartile (QQ) of slab avalanches of original and synthetic data (Smote).





**Fig. A7.** Comparison of original and synthetic datasets for wet avalanches using PCA.



**Fig. A8.** Comparison of original and synthetic datasets for slab avalanches using PCA.

**Table A1.** Explanation of a contingency table of the confusion matrix for the final model performance fit see Fig. 9.

		Observed	
		No	Yes
Modelled	No	true negatives	misses
	Yes	false alarms	true positives

## References

- Avalanche danger in Krkonoše National Park, (last access: 1 November 2021).
- Krkonoše National Park and surroundings, Czech Republic, <https://www.interreg-central.eu/Content.Node/MaGICLandscapes.html>, (last  
605 access: 14 July 2022), 2020.
- Baggi, S. and Schweizer, J.: Characteristics of wet-snow avalanche activity: 20 years of observations from a high alpine valley (Dischma, Switzerland), *Natural Hazards*, 50, 97–108, 2009.
- Ballesteros-Cánovas, J. A., Trappmann, D., Madrigal-González, J., Eckert, N., and Stoffel, M.: Climate warming enhances snow avalanche risk in the Western Himalayas, *Proceedings of the National Academy of Sciences*, 115, 3410–3415, 2018.
- 610 Bellaire, S., van Herwijnen, A., Mitterer, C., and Schweizer, J.: On forecasting wet-snow avalanche activity using simulated snow cover data, *Cold Regions Science and Technology*, 144, 28–38, <https://doi.org/10.1016/j.coldregions.2017.09.013>, 2017.
- Beniston, M., Farinotti, D., Andreassen, L. M., Coppola, E., Eckert, N., Fantini, A., Giacona, F., Hauck, C., Huss, M., Huwald, H., Lehning, M., López-Moreno, J.-I., Magnusson, J., Marty, C., Morán-Tejeda, E., Morin, S., Naaim, M., Provenzale, A., and Vincent, C.: The European mountain cryosphere: A review of its current state, trends, and future challenges, *The Cryosphere*, 12, 759–794,  
615 <https://doi.org/10.5194/tc-12-759-2018>, 2018.
- Biecek, P. and Burzykowski, T.: Explanatory model analysis: explore, explain, and examine predictive models, CRC Press, 2021.
- Bintanja, R.: The impact of Arctic warming on increased rainfall, *Scientific Reports*, 8, 6–11, <https://doi.org/10.1038/s41598-018-34450-3>, 2018.
- Blahušiaková, A., Matoušková, M., Jenicek, M., Ledvinka, O., Kliment, Z., Podolinská, J., and Snopková, Z.: Snow and climate trends  
620 and their impact on seasonal runoff and hydrological drought types in selected mountain catchments in Central Europe, vol. 0, Taylor & Francis, <https://doi.org/10.1080/02626667.2020.1784900>, 2020.
- Blahůt, J., Klimeš, J., Balek, J., Hájek, P., Červená, L., and Lysák, J.: Snow avalanche hazard of the Krkonoše National Park, Czech Republic, *Journal of Maps*, 13, 86–90, <https://doi.org/10.1080/17445647.2016.1262794>, 2017.
- Bogena, H. R., Herrmann, F., Jakobi, J., Brogi, C., Ilias, A., Huisman, J. A., Panagopoulos, A., and Pisinaras, V.: Monitoring of snowpack  
625 dynamics with cosmic-ray neutron probes: A comparison of four conversion methods, *Frontiers in water*, 2, 19, 2020.
- Castebrunet, H., Eckert, N., Giraud, G., Durand, Y., and Morin, S.: Projected changes of snow conditions and avalanche activity in a warming climate: the French Alps over the 2020–2050 and 2070–2100 periods, *The Cryosphere*, 8, 1673–1697, 2014.
- Chawla, N. V., Bowyer, K. W., Hall, L. O., and Kegelmeyer, W. P.: SMOTE: synthetic minority over-sampling technique, *Journal of artificial intelligence research*, 16, 321–357, 2002.
- 630 Christen, M., Kowalski, J., and Bartelt, P.: RAMMS: Numerical simulation of dense snow avalanches in three-dimensional terrain, *Cold Regions Science and Technology*, 63, 1–14, 2010.
- Corona, C., Saez, J. L., Stoffel, M., Rovéra, G., Edouard, J.-L., and Berger, F.: Seven centuries of avalanche activity at Echalp (Queyras massif, southern French Alps) as inferred from tree rings, *The Holocene*, 23, 292–304, 2013.
- Dreier, L., Harvey, S., van Herwijnen, A., and Mitterer, C.: Relating meteorological parameters to glide-snow avalanche activity, *Cold  
635 Regions Science and Technology*, 128, 57–68, <https://doi.org/10.1016/j.coldregions.2016.05.003>, 2016.
- Eckerstorfer, M. and Christiansen, H.: Relating meteorological variables to the natural slab avalanche regime in High Arctic Svalbard, *Cold Regions Science and Technology*, 69, 184–193, <https://doi.org/https://doi.org/10.1016/j.coldregions.2011.08.008>, international Snow Science Workshop 2010 Lake Tahoe, 2011.

- Eckert, N., Keylock, C., Castebrunet, H., Lavigne, A., and Naaim, M.: Temporal trends in avalanche activity in the French Alps and subre-  
640 gions: from occurrences and runout altitudes to unsteady return periods, *Journal of Glaciology*, 59, 93–114, 2013.
- Engel, Z., Nývlt, D., Křížek, M., Treml, V., Jankovská, V., and Lisá, L.: Sedimentary evidence of landscape and climate  
history since the end of MIS 3 in the Krkonoše Mountains, Czech Republic, *Quaternary Science Reviews*, 29, 913–927,  
<https://doi.org/10.1016/j.quascirev.2009.12.008>, 2010.
- Feng, S. and Hu, Q.: Changes in winter snowfall/precipitation ratio in the contiguous United States, *Journal of Geophysical Research*  
645 *Atmospheres*, 112, 1–12, <https://doi.org/10.1029/2007JD008397>, 2007.
- Gądek, B., Kaczka, R. J., Rączkowska, Z., Rojan, E., Casteller, A., and Bebi, P.: Snow avalanche activity in Żleb Żandarmerii in a time of  
climate change (Tatra Mts., Poland), *Catena*, 158, 201–212, 2017.
- García-Hernández, C., Ruiz-Fernández, J., Sánchez-Posada, C., Pereira, S., Oliva, M., and Vieira, G.: Reforestation and land use change as  
drivers for a decrease of avalanche damage in mid-latitude mountains (NW Spain), *Global and Planetary Change*, 153, 35–50, 2017.
- 650 Gauthier, F., Germain, D., and Héту, B.: Logistic models as a forecasting tool for snow avalanches in a cold maritime climate: northern  
Gaspésie, Québec, Canada, *Natural hazards*, 89, 201–232, 2017.
- Germain, D., Filion, L., and Héту, B.: Snow avalanche activity after fire and logging disturbances, northern Gaspé Peninsula, Quebec, Canada,  
*Canadian Journal of Earth Sciences*, 42, 2103–2116, 2005.
- Germain, D., Filion, L., and Héту, B.: Snow avalanche regime and climatic conditions in the Chic-Choc Range, eastern Canada, *Climatic*  
655 *Change*, 92, 141–167, 2009.
- Germain, D., Pop, O. T., Gratton, M., Holobăcă, I.-H., and Burada, C.: Snow-avalanche hazard assessment based on dendrogeomorphic  
reconstructions and classification tree algorithms for ski area development, Parâng Mountains, Romania, *Cold Regions Science and*  
*Technology*, p. 103612, 2022.
- Giacona, F., Eckert, N., Mainieri, R., Martin, B., Corona, C., Lopez-Saez, J., Monnet, J.-M., Naaim, M., and Stoffel, M.: Avalanche activity  
660 and socio-environmental changes leave strong footprints in forested landscapes: a case study in the Vosges medium-high mountain range,  
*Annals of Glaciology*, 59, 111–133, 2018.
- Giacona, F., Eckert, N., Corona, C., Mainieri, R., Morin, S., Stoffel, M., Martin, B., and Naaim, M.: Upslope migration of snow avalanches  
in a warming climate, *Proceedings of the National Academy of Sciences*, 118, 2021.
- Gregorutti, B., Michel, B., and Saint-Pierre, P.: Correlation and variable importance in random forests, *Statistics and Computing*, 27, 659–  
665 678, 2017.
- Hendrikx, J., Murphy, M., and Onslow, T.: Classification trees as a tool for operational avalanche forecasting on the Seward Highway, Alaska,  
*Cold Regions Science and Technology*, 97, 113–120, 2014.
- Hock, R., Rasul, G., Adler, C., Cáceres, B., Gruber, S., Hirabayashi, Y., Jackson, M., Käab, A., Kang, S., Kutuzov, S., et al.: High mountain  
areas, 2019.
- 670 Horton, S., Towell, M., and Haegeli, P.: Examining the operational use of avalanche problems with decision trees and model-generated  
weather and snowpack variables, *Natural Hazards and Earth System Sciences*, 20, 3551–3576, 2020.
- Hynčica, M. and Huth, R.: Long-term changes in precipitation phase in Czechia, *Geografie-Sbornik CGS*, 124, 41–55,  
<https://doi.org/10.37040/geografie2019124010041>, 2019.
- James, G., Witten, D., Hastie, T., and Tibshirani, R.: An introduction to statistical learning, vol. 112, Springer, 2013.
- 675 Janík, T., Zýka, V., Skokanová, H., Borovec, R., Demková, K., Havlíček, M., Chumanová, E., Houška, J., and Romportl, D.: Vývoj  
krkonošské krajiny-od založení Krkonošského národního parku po současnost, *Opera Corcontica*, pp. 65–76, 2020.

- Jeník, J.: *Alpínská vegetace Krkonoš, Králického Sněžníku a Hrubého Jeseníku: teorie anemo-orografických systém*, Nakl. Československé Akademie Věd, 1961.
- Juras, R., Pavlásek, J., Blahůt, J., Bašta, P., Kloze, Z., Moudrý, V., and Balek, J.: <https://doi.org/10.13140/2.1.1591.6483>.
- 680 Juras, R., Blöcher, J. R., Jenicek, M., Hotovy, O., and Markonis, Y.: What affects the hydrological response of rain-on-snow events in low-altitude mountain ranges in Central Europe?, *Journal of Hydrology*, p. 127002, 2021.
- Kliegrová, S. and Kašičková, L.: Changes in air temperature and precipitation totals in the period 1961–2016 in the Giant Mountains, in: *Meteorological Bulletin*, vol. 72, p. 11, 2019.
- Laute, K. and Beylich, A. A.: Potential effects of climate change on future snow avalanche activity in western Norway deduced from  
685 meteorological data, *Geografiska Annaler: Series A, Physical Geography*, 100, 163–184, 2018.
- Lavigne, A., Eckert, N., Bel, L., and Parent, E.: Adding expert contributions to the spatiotemporal modelling of avalanche activity under different climatic influences, *Journal of the Royal Statistical Society: Series C (Applied Statistics)*, 64, 651–671, 2015.
- Le Roux, E., Evin, G., Eckert, N., Blanchet, J., and Morin, S.: Elevation-dependent trends in extreme snowfall in the French Alps from 1959 to 2019, *The Cryosphere*, 15, 4335–4356, 2021.
- 690 Liaw, A. and Wiener, M.: Classification and Regression by randomForest, *R News*, 2, 18–22, <https://CRAN.R-project.org/doc/Rnews/>, 2002.
- Loy, A., Follett, L., and Hofmann, H.: Variations of Q–Q plots: the power of our eyes!, *The American Statistician*, 70, 202–214, 2016.
- Lunardon, N., Menardi, G., and Torelli, N.: ROSE: a Package for Binary Imbalanced Learning, *R Journal*, 6, 82–92, 2014.
- Maćkiewicz, A. and Ratajczak, W.: Principal components analysis (PCA), *Computers & Geosciences*, 19, 303–342, 1993.
- Mainieri, R., Favillier, A., Lopez-Saez, J., Eckert, N., Zgheib, T., Morel, P., Saulnier, M., Peiry, J.-L., Stoffel, M., and Corona, C.: Impacts  
695 of land-cover changes on snow avalanche activity in the French Alps, *Anthropocene*, 30, 100 244, 2020.
- Mair, R. and Nairz, P.: *Lawine*, *Die*, 10, 10–11, 2011.
- Marienthal, A., Hendriks, J., Birkeland, K., and Irvine, K. M.: Meteorological variables to aid forecasting deep slab avalanches on persistent weak layers, *Cold Regions Science and Technology*, 120, 227–236, <https://doi.org/https://doi.org/10.1016/j.coldregions.2015.08.007>, 2015.
- 700 Martin, E., Giraud, G., Lejeune, Y., and Boudart, G.: Impact of a climate change on avalanche hazard, *Annals of Glaciology*, 32, 163–167, 2001.
- Marty, C., Tilg, A. M., and Jonas, T.: Recent Evidence of Large-Scale Receding Snow Water Equivalents in the European Alps, *Journal of Hydrometeorology*, 18, <https://doi.org/10.1175/JHM-D-16-0188.1>, 2017.
- Möhle, S., Bründl, M., and Beierle, C.: Modeling a system for decision support in snow avalanche warning using balanced random forest  
705 and weighted random forest, in: *International Conference on Artificial Intelligence: Methodology, Systems, and Applications*, pp. 80–91, Springer, 2014.
- Murtagh, F. and Legendre, P.: Ward’s hierarchical agglomerative clustering method: which algorithms implement Ward’s criterion?, *Journal of classification*, 31, 274–295, 2014.
- Naaim, M., Eckert, N., Giraud, G., Faug, T., Chambon, G., Naaim-Bouvet, F., and Richard, D.: Impact of climate warming on avalanche  
710 activity in French Alps and increase of proportion of wet snow avalanches, *HOUILLE BLANCHE-REVUE INTERNATIONALE DE L’EAU*, pp. 12–20, 2016.
- Nedelcev, O. and Jeníček, M.: Trends in seasonal snowpack and their relation to climate variables in mountain catchments in Czechia, *Hydrological Sciences Journal*, 2021.

- Notarnicola, C.: Hotspots of snow cover changes in global mountain regions over 2000–2018, *Remote Sensing of Environment*, 243, 111–118, 2020.
- 715 Peitzsch, E. H., Hendrikx, J., Fagre, D. B., and Reardon, B.: Examining spring wet slab and glide avalanche occurrence along the Going-to-the-Sun Road corridor, Glacier National Park, Montana, USA, *Cold regions science and technology*, 78, 73–81, 2012.
- Peitzsch, E. H., Pederson, G. T., Birkeland, K. W., Hendrikx, J., and Fagre, D. B.: Climate drivers of large magnitude snow avalanche years in the US northern Rocky Mountains, *Scientific reports*, 11, 1–13, 2021.
- 720 Probst, P., Wright, M. N., and Boulesteix, A.-L.: Hyperparameters and tuning strategies for random forest, *Wiley Interdisciplinary Reviews: Data Mining and Knowledge Discovery*, 9, e1301, 2019.
- Quervain, M., De Crecy, L., LaChapelle, E., Losev, K., and Shoda, M.: Avalanche classification, *Hydrological Sciences Bulletin*, 18, 391–402, 1973.
- Reuter, B., Mitterer, C., and Bellaire, S.: 7.3 WARNSIGNAL KLIMA: Die Lawinengefahr im Klimawandel, 2020.
- 725 Schattan, P., Baroni, G., Oswald, S. E., Schöber, J., Fey, C., Kormann, C., Huttenlau, M., and Achleitner, S.: Continuous monitoring of snowpack dynamics in alpine terrain by aboveground neutron sensing, *Water Resources Research*, 53, 3615–3634, 2017.
- Schweizer, J. and Föhn, P. M.: Avalanche forecasting—an expert system approach, *Journal of Glaciology*, 42, 318–332, 1996.
- Schweizer, J., Bruce Jamieson, J., and Schneebeli, M.: Snow avalanche formation, *Reviews of Geophysics*, 41, 2003.
- Schweizer, J., Mitterer, C., and Stoffel, L.: On forecasting large and infrequent snow avalanches, *Cold Regions Science and Technology*, 59, 730 234–241, 2009.
- Sielenou, P. D., Viallon-Galinier, L., Hagenmuller, P., Naveau, P., Morin, S., Dumont, M., Verfaillie, D., and Eckert, N.: Combining random forests and class-balancing to discriminate between three classes of avalanche activity in the French Alps, *Cold Regions Science and Technology*, 187, 103–116, <https://doi.org/https://doi.org/10.1016/j.coldregions.2021.103276>, 2021.
- Soteres, R. L., Pedraza, J., and Carrasco, R. M.: Snow avalanche susceptibility of the Circo de Gredos (Iberian Central System, Spain), 735 *Journal of Maps*, 16, 155–165, 2020.
- Součková, M., Juras, R., Dyrtr, K., Moravec, V., Blöcher, J. R., and Hanel, M.: What weather variables are important for wet and slab avalanches under a changing climate in low altitude mountain range in Czechia?, <https://doi.org/10.5281/zenodo.7041129>, 2022.
- Spusta, V. and Kociánová, M.: Avalanche cadastre in the Czech part of the Krkonoše Mts. (Giant Mts.) during winter seasons 1961/62 – 1997/98, *Opera Corcontica*, 35, 3–205, 1998.
- 740 Spusta, V., Spusta, V. J., and Kociánová, M.: Lavinový katastr a zimní situace na hřebenu české části Krkonoš v období 1998 / 99 – 2002 / 03. Avalanche Cadastre and Winter Condition in Summit Area of the Giant Mts. (Czech part) during 1998 / 1999 – 2002 / 2003, *Opera Corcontica*, 40, 5–86, 2003.
- Spusta, V., Spusta, V. J., and Kociánová, M.: Lavinový katastr české části Krkonoš v zimním období 2003 / 04 až 2005 / 06 Avalanche cadaster of the Czech part of the Giant Mountains in winter season 2003 / 04 – 2005 / 06, pp. 81–93, 2006.
- 745 Spusta, V., Spusta, V. J., and Kociánová, M.: Lavinový katastr a zimní situace v české části Krkonoš Avalanche cadastre and winter conditions in the czech part of the Krkonoše Mts. in the winter seasons, *Opera Corcontica*, 56, 21–110, 2020.
- Statham, G., Haegeli, P., Greene, E., Birkeland, K., Israelson, C., Tremper, B., Stethem, C., McMahon, B., White, B., and Kelly, J.: A conceptual model of avalanche hazard, *Natural Hazards*, 90, 663–691, 2018.
- Strapazzon, G., Schweizer, J., Chiambretti, I., Brodmann Maeder, M., Brugger, H., and Zafren, K.: Effects of Climate Change on Avalanche 750 Accidents and Survival, *Frontiers in Physiology*, 12, 450, <https://doi.org/10.3389/fphys.2021.639433>, 2021.

- Stull, R.: Wet-bulb temperature from relative humidity and air temperature, *Journal of applied meteorology and climatology*, 50, 2267–2269, 2011.
- Štursa, J., Jeník, J., and Váňa, J.: The alpine forest-limit in the Giant Mts (Central Europe) and Abisko Mts (subarctic Sweden), *Opera Corcontica*, 47, 129–164, 2010.
- 755 Techel, F., Zweifel, B., and Winkler, K.: Analysis of avalanche risk factors in backcountry terrain based on usage frequency and accident data in Switzerland, *Natural Hazards and Earth System Sciences*, 15, 1985–1997, 2015.
- Techel, F., Jarry, F., Kronthaler, G., Mitterer, S., Nairz, P., Pavsek, M., Valt, M., and Darms, G.: Avalanche fatalities in the European Alps: Long-term trends and statistics, *Geographica Helvetica*, 71, 147–159, <https://doi.org/10.5194/gh-71-147-2016>, 2016.
- Therneau, T. and Atkinson, B.: rpart: Recursive Partitioning and Regression Trees, <https://CRAN.R-project.org/package=rpart>, r package version 4.1-15, 2019.
- 760 Tolasz, R. e. a.: Atlas podnebí Česka—Climate atlas of Czechia, International series of monographs on physics, Český hydrometeorologický ústav—Univerzita Palackého v Olomouci, 12007.
- Vrba, M. and Spusta, V.: Avalanche Survey and Map of Krkonoše Mountains, *Opera Corcontica*, 12, 65–90, 1975.
- Vrba, M. and Spusta, V.: The avalanche cadastre of the Krkonoše Mountains, *Opera Concordica*, 28, 47–58, 1991.
- 765 Zahradníček, P., Brázdil, R., Štěpánek, P., and Řezníčková, L.: Differences in wind speeds according to measured and homogenized series in the Czech Republic, 1961–2015, *International Journal of Climatology*, 39, 235–250, 2019.
- Zgheib, T., Giacona, F., Granet-Abisset, A.-M., Morin, S., and Eckert, N.: One and a half century of avalanche risk to settlements in the upper Maurienne valley inferred from land cover and socio-environmental changes., *Global Environmental Change*, 65, 102 149, 2020.
- Zgheib, T., Giacona, F., Granet-Abisset, A.-M., Morin, S., Lavigne, A., and Eckert, N.: Spatio-temporal variability of avalanche risk in the French Alps, *Regional Environmental Change*, 22, 1–18, 2022.
- 770