

Dear Editor,

We are pleased to provide the final draft of our manuscript entitled "**Update of the tsunami catalogue of New Caledonia using a decision table based on seismic data and maregraphic records**". Answers to the referees' comments are listed below.

Referee #1

The referee detailed about references lacking to our manuscript references list. It is a mistake from us to have removed those references in our review process in Word software instead of keeping them. It is now fixed.

Concerning Figure 2, we fully agree with him; it was a mistake from us in the text and the beginning time of the considered events has been changed to "January 1, 1970"; the data used for preparing the graph have been also checked.

Concerning Figure 4, "P" has been changed by "F" to be in agreement with the manuscript.

Table 2 and Table 3 column "Distance to NC center" has been corrected: it is true that keeping decimals is a nonsense for such distances in hundreds of kilometers.

Referee #2

The referee mentioned the fact that decision table is more appropriate than algorithm and he is right. We agree and change the word in the manuscript.

Considering the 1960 tsunami, we mentioned it in the abstract as well as at the end of the part 1.

Comment about role of the rupture characteristics and dynamics on the tsunami generation has been considered in section 2.4.

As requested, the choice of the distance criterion linked to the magnitude criterion has been more discussed in section 2.4. We are aware of the role played by the strike at a given subduction zone, but the objective was to select all the events able to trigger a tsunami being recorded on tide gauges in New Caledonia.

In section 2.5 the search procedure is applied to the whole dataset. There is no succession of conditional tests. Of course, we have removed the 6-digit accuracy of the columns in table 2 and 3, as requested by another reviewer.

The locations of Grande Terre, Loyalty Islands, Nouméa, Ponérihouen, Isle of Pines, Canala and Mou have been added to figure 5. Concerning the potential of tsunami record in Nouméa (along the West coast), paragraph 2.6 has been improved as requested.

We cut off the sentence about the arrival azimuths of tsunamis in section 2.6.

We fully agree with the referee about the confusion on the magnitude criterion of 6 or 6.3 at the beginning of section 3. It doesn't make any change on the results since the events between 6 and 6.3 were located outside of the Pacific Ocean and/or they did not produce a sufficient tsunami to be recorded in New Caledonia, we decided to look only at earthquakes of magnitude $M_w > 6.3$ as he indicated.

Section 3.1 has been re-organized and better hierarchized as the referee recommended.

The sentence dealing with the different percentages for the 2 studied periods (1900-->2009, 2009-->2019) has been improved. By the way, the Sahal catalogue is based on a different approach and our methodology doesn't help to improve the catalogue before 2009.

Although we noticed a difference of signal amplitude 3 times more important at Chaleix than at Numbo during one event, we have not explored the issue further as the two tide gauges are in different bays and are likely affected by different resonance mechanisms.

The data concerning the December 5, 2018 tsunami are kept for a further publication focusing on this event.

We added a sentence in the sea-level data section to describe our method for de-tiding. For the Nouméa tide gauge, it is done with a multiyear time-series and it is therefore very accurate.

Figure 12 only shows the results of our study: the location of the earthquakes having triggered a tsunami recorded in New Caledonia. By analyzing the Pacific data about tsunamis (NOAA NGDC catalogue) we found that no tsunami triggered by distant earthquake located far from Nouméa (> 2500 km) and deeper than 100 km was recorded in New Caledonia. The same way, no regional tsunami has been related to an earthquake deeper than 100 km and with magnitude lower than 7.5. The scale bar has been modified in accordance (depth > 100 km has been removed).

Unfortunately, the scarce tsunami amplitude data along the coast of New Caledonia does not allow yet to produce a relevant graph of tsunami heights as a function of the earthquake magnitude to be useful for pre-operational procedures. We still think that the distance criterion is a relevant to analyze the dataset. Note that a shallow (< 100 km) earthquake with magnitude higher than 7.5 is kept in our process.

Concerning paleotsunami research, it is true that we do not mention that point because there is no published research on this topic in New Caledonia. A paleotsunami research project has just been funded and will be held in a few month in 2019.

Answers to the other remarks:

- L.36-37: the sentence has been modified as requested.

- L. 55: corrected.

- L. 69: corrected.

- L. 98: modified.

- L. 222: corrected.

- L. 232: corrected.

- L. 282: corrected.

- L. 325: modified.

- Figure 1: The inactive subduction zones are indicated on the figure as red dashed lines. Convergences rates have been added. Legend has been modified.

- Figure 2: improved with the two requested lines.
- Figure 4: done.
- Figure 5: added.

Best regards,

The authors.

Update of the tsunami catalogue of New Caledonia using a decision table based on seismic data and maregraphic records.

Jean Roger¹, Bernard Pelletier², Jérôme Aucan¹

¹LEGOS, Institut de Recherche pour le Développement, 101, Promenade Roger Laroque, BP A5 98848 Nouméa Cedex

²GEOAZUR, Institut de Recherche pour le Développement, 101, Promenade Roger Laroque, BP A5 98848 Nouméa Cedex

Correspondence to: Jean Roger (jeanrog@hotmail.fr)

Abstract. 14 years ago, the December 26, 2004 Indian Ocean tsunami brought to the entire World the destruction capability of tsunamis. Since then, many research programs have been initiated to try to better understand the phenomenon and its related hazards, and to improve the early warning systems for the exposed coastal populations. Pacific Islands Countries and Territories (PICTs) are especially vulnerable to tsunamis. Amongst them, New Caledonia is a French overseas territory located in the South-western Pacific and exposed to several tsunamis sources. In 2010, a catalogue of tsunamis that were visually observed or measured in New Caledonia was published. Since this first study, several events occurred between 2009 and 2019 and an update of this catalogue was necessary within the framework of a tsunami hazard assessment project (TSUCAL). To complete this catalogue, a decision ~~algorithm-table~~ has been designed to select potential tsunamigenic events within the USGS earthquake database, using criteria on the distance to New Caledonia, the magnitude and the hypocenter depth. Then a cross-comparison between these earthquake events, the NOAA NGDC tsunami catalogue and local tide gauge records provided 25 events that were recorded in New Caledonia for the period from September 30, 2009 to January 10, 2019. These events are added to the 12 events reported with certainty during previous studies, leading to a number of 37 tsunamis triggered by earthquakes reported ~~or recorded~~ in New Caledonia since 1875. Six of them have been identified only thanks to local tide gauges, supporting the fact that instrumental recording of tsunamis is paramount for tsunami hazard studies, from early warning to the validation of coastal models. In addition, ~~previously-unpublished~~ tide gauge data is provided for ~~other-already-reported tsunamis- the 1960 Chile tsunami. as well as tsunamis with unspecified date and source.~~

1 General settings

New Caledonia is located ~200 km of the Vanuatu subduction zone on the south-western Pacific Ocean between Australia and Vanuatu (Fig. 1). This subduction zone is part of the Pacific-Australia (P-A) plates boundary that runs from New-Zealand to the South to Papua-New Guinea to the North. Along this boundary the convergence rate between the Australian and Pacific plates has been estimated to 60-120 mm/yr (DeMets et al., 2010). However due to several micro-plates located between the two major plates and especially back-arc spreadings, convergence rates at trenches can largely exceeds the P-A motion and these rates were measured at up to 17 cm/yr in northern Vanuatu and 24 cm/yr in northern Tonga (Pelletier and Louat, 1989; Bevis et 1995; Pelletier et al., 1998; Calmant et al., 2003). Over the past decades, this convergence zone has clearly demonstrated its ability to generate strong shallow earthquakes. ~~although m~~ Moment magnitude does not exceed 8.2 according to the USGS catalogue but magnitude above 8.2 are possible and likely tsunamigenic.

New Caledonia is an archipelago that was originally populated by Austronesians circa 3000 years ago (Forestier, 1994). It has been discovered by Europeans on September 4, 1774 (Faivre, 1950). But according to the same author, foreigners really began to settle here only after 1840, appearing with them written reports of uncommon natural phenomena, including tsunamis. Thus, the reported written history of tsunamis covers only the last 180 years, and only the biggest events have left available information especially when associated to an earthquake felt by the population; it concerns mainly earthquakes occurring at the Vanuatu subduction zone. In addition, due to its oceanic location, New Caledonia is also exposed to tsunamis coming from other parts of the Pacific Ocean, from regional sources (e.g. Solomon and Tonga-Kermadec trenches ; Fig. 1) to transoceanic sources (e.g. Chile, Japan or Kuril subduction zones). Most of the time these tsunamis have been reported in coeval reports by witnesses or transmitted orally in the Kanak tradition and collected in a catalogue by Sahal et al. (2010) for the period running from 1875 to 2009 as an update of the previous catalogues from Soloviev and Go (1984) and Louat and Baldassari (1989).

Comment [J1]: corrected

The present study builds on the catalogue from Sahal et al. (2010) using a decision ~~algorithm-table~~ and local maregraphic data adding the events being recorded since then and adding unrevealed information concerning previously mentioned events [as for example the 1960 Chile tsunami](#).

2 Methodology

This study is based on the USGS earthquake catalogue that provides accurate information on seismic events all around the World since January 1, 1900 (U.S. Geological Survey, 2019). ~~An algorithm~~ [A decision table](#) has been created to select within this database the events that were potentially tsunamigenic and with potential to reach the New Caledonia coastlines. It is described hereafter.

The events extracted from the USGS database by this ~~algorithm-decision table~~ are then cross-compared to the reported tsunami from the NOAA NGDC tsunami database (and NOAA PTWC bulletin archives) and to local maregraphic data.

2.1 ~~Search algorithm~~ [Decision table](#)

The first step was to collect all the available earthquakes from the catalogue for the Pacific Ocean region. We decided to select only the $M_w > 6.0-3$ events according to the global tsunami databases, like the Historical Tsunami Database for the World Ocean -HTDB/WLD (<http://tsun.sssc.ru/tsunami-database/index.php>) or the NOAA NGDC/WDS Global Historical Tsunami Database (www.ngdc.noaa.gov/hazard/tsu_db.shtml), which empirically show that there is no tsunamis triggered by earthquakes of magnitude $M_w < 6.3$ (Tinti, 1991). For information, Bolt et al. (1975) indicate that the maximum run-up for a tsunami generated by a $M_w = 6.5$ earthquake would be no more than 0.5-0.75 m and Walker (2005) shows that tsunamigenic earthquakes with moment magnitudes $M_w \geq 8.6$ had all a Pacific-wide impact. On the 10th of January 2019, this collection represents ~~7255-4902~~ $M_w \geq 6.0-3$ earthquakes [on the whole Pacific Ocean \(on a \$66.295^\circ\text{S}\$, \$61.972^\circ\text{N}\$, \$118.477^\circ\text{W}\$, \$297.7738^\circ\text{W}\$ \)](#) box since July 29, 1900.

Formatted: Highlight

Formatted: Highlight

Formatted: Highlight

Then it is important to select events able to trigger tsunami with sufficient energy to reach New Caledonia. Ward (1980) has indicated that tsunami generation is dependent upon the following criteria: the faulting mechanisms (mainly dip and slip), the magnitude (energy release) and the epicenter depth (focal depth). Thus, we consider all

75 the faulting mechanisms without any distinction, integrating the distance from the source to New Caledonia to
the earthquake magnitude and epicenter depth in the ~~selection algorithm~~ [decision table](#).
Notice that the global tsunami catalogue is considered as a whole, and not only in the Pacific Ocean region,
according to the fact that catastrophic events like the 2004 Sumatra (Indian Ocean) tsunami could be recorded by
tide gauges all around the World (Titov et al., 2005; [Rabinovich and Thomson, 2007](#)).

Comment [J2]: corrected

80 2.2 The faulting mechanisms

Although thrust and normal faults are responsible of the majority of the strong subduction earthquakes and
tsunamis, Tanioka and Satake (1996) have shown that in a specific case, i.e. when the rupture occurs on a steep
slope with a horizontal displacement significantly larger than the vertical displacement, horizontal movement -
strike-slip faulting- along a fault plane is also able to trigger a tsunami. In addition, Legg and Borrero (2001)
85 and Borrero et al. (2004) have also shown that tectonic events occurring on strike-slip faults with sinuous traces
could trigger tsunamis by the effect of uplift and subsidence along compressional and extensional relays. Thus,
we decided to consider all faulting mechanisms because they are all potentially able to exhibit a vertical
component of ocean bottom disturbance, the only parameter required to disturb the water column and generate a
tsunami.

90 2.3 Relationship between earthquake magnitude and focal depth and tsunami generation

We use the data from NOAA NGDC/WDS Global Historical Tsunami Database to plot the earthquake focal
depth as a function of magnitude for 440 tsunamigenic earthquakes around the World from January 1, 1970 to
August 24, 2018 (Fig. 2). **Only 28-47 (6.3-10.7 %) of these events have Mw < 6.9-3 and 9 (2.0 %) have been
located at a depth of more than 100 km** ~~(cette phrase concerne les tsunami mondiaux on peut la retirer)~~.
95 Considering that these events are not located within the Pacific Ocean and/or they did not produce a sufficient
tsunami to be recorded in New Caledonia, we decided to look only at earthquakes of magnitude Mw > 6.9-3 and
focal depth < 100 km in the following. Note that these values are consistent with different Early warning systems
criteria ([Tinti, 1991](#); UNESCO/IOC, 2009).

Formatted: Highlight

Formatted: Highlight

Formatted: Highlight

Formatted: Highlight

Formatted: Highlight

2.4 Tsunami amplitude and distance from the source

100 The tsunami amplitude, its wavelength and frequency components, directly linked to the [earthquake magnitude](#)
~~and faulting-focal mechanisms~~ [and rupture dynamics](#), determine the extent of the impacted zone: local, regional
or ocean-wide impact. In fact, a tsunami triggered by a landslide or a moderate earthquake is more inclined to
dispersive phenomenon than a tsunami triggered by a large earthquake because dispersion is directly linked to
the wavelength and frequency content, the water depth and the propagation distance (Glimsdal et al., 2013). In
105 fact, smaller the source is, quicker is the energy decay and finally the disappearance of the tsunami waves over
the time and distance from the source (Rabinovich et al., 2013). For example, Tanioka et al. (2018) show the role
of this dispersion phenomenon when looking at the DART buoy record of the tsunami triggered by the Mw 6.9
2016 Salvador-Nicaragua earthquake: in that specific case, the linear long waves theory overestimates
considerably the numerical modeling results in comparison to the results obtained by the help of linear
110 Boussinesq equations, taking into account dispersion effect.

We decided to make an event sorting upon a magnitude and distance criteria of $M = 7.5$ and $D = 2500$ km because: ~~i) Considering that~~ the local and regional sources (from the Solomon, Vanuatu and Tonga-Kermadec subduction zones) are located within a circle of radius ~ 2500 km (Fig. 3) and ~~ii) that~~ the far-field potential tsunami ~~sources triggered by earthquakes of moment magnitude below 7.5 could not be recorded in New Caledonia according to historical data, and far-field sources could only be located between 4400 km (for the Mariana Trench, offshore Guam) and more than 10000 km away from New Caledonia (for Chile subduction zone), are located between 4400 km (for the Mariana Trench, offshore Guam) and more than 10000 km away from New Caledonia (for Chile subduction zone), we decided to make an event sorting upon this distance criterion of $D = 2500$ km.~~

2.5 Construction of the ~~algorithm~~ decision table

The ~~algorithm~~ decision table is based on the previous explanations and lays down the rules to keep or reject a considered event from the USGS catalogue with respect to specific conditions on three different parameters: the earthquake magnitude (M), the focal depth (F) and the distance between the source and New Caledonia (D). Four cases are considered to select whether an event is kept or rejected. They are summarized on figure 4.

For the calculations of distance from an earthquake epicenter to New Caledonia on a sphere, an approximate theoretical center of New Caledonia has been determined calculating the barycentre of a triangle made with the three following points: $[163.576030, -19.539454^\circ]$ for the northernmost point of the archipelago, $[167.570644, -22.762149]$ for the southernmost point and $[168.135799^\circ, -21.450552^\circ]$ for the easternmost point. Its coordinates are $[166.427491, -21.250718]$.

2.6 Sea-level data

The tide gauge stations of New Caledonia are located on figure 5. All the tide gauges were installed along the East Coast of the Grande Terre of New Caledonia and in the Loyalty Islands, except the historical tide gauge in Nouméa (Chaleix then Numbo), the territory capital located on the West coast of Grande Terre. ~~(Aucan et al., 2017a). Because of its location on the opposite side of all the reported main incoming tsunami pathways—azimuthal direction window from -304°N (Papua New Guinea) to -160°N (New Zealand)—, it is likely impossible to record small tsunamis (generally arbitrarily < 1 m) on this tide gauge.~~ Instrumental records of hourly sea level for Nouméa has been back extended to 1957 (Aucan et al., 2017a), and in the present paper we show ~~previously~~ unpublished records of digitized high frequency sea level data.

All the tide gauges started recording high frequency sea level (with sampling rates faster than 5 minutes) only after 2010 or later. The tide gauge characteristics are summarized on table 1.

In addition to these tide gauges, several pressure gauges have also been installed by the IRD in Poindimié, Ouvéa and Uïtoe (Fig. 2) within the framework of the ReefTEMPS project (Varillon et al., 2018) or the EMIL project (Aucan et al., 2017b). Their characteristics are also summarized in table 1.

~~Tide gauge and pressure data were detided by removing the predicted tide. The predicted tide was calculated with an harmonics analysis of the entire dataset available for each site, all of which were longer than 6 months.~~

Comment [J3]: modified as requested

Comment [J4]: modified as requested

3 Tsunami catalogue

3.1 Events after September 29, 2009 ~~Results of extraction~~

The ~~algorithm decision table~~ has been able to extract ~~1337-967~~ events ($M_w \geq 6.3$) from the USGS earthquakes catalogue between July 29, 1900 and January 10, 2019. ~~If the magnitude threshold is upgraded from 6.0 to 6.3 ($M_w \geq 6.3$) the number of extracted events is reduced to 967. Thus according to the low potential of such earthquakes to trigger tsunamis, only earthquakes of magnitude $M_w \geq 6.3$ are considered afterwards.~~

3.1.1 Present in the NOAA NGDC catalogue and recorded on tide gauges

a) Looking in the NOAA NGDC catalogue

At first we decided to look only at the events that occurred after the period considered by Sahal et al. (2010), i.e. after the September 29, 2009 Samoa tsunami. It represents 113 ~~from the 967 extracted~~ events ~~from the previous extraction (113/967)~~. But not all these events triggered a tsunami and even less a tsunami able to reach New Caledonia. To look at their tsunamigenic capabilities, this list of earthquakes was cross-compared with the NOAA NGDC/WDS Global Historical Tsunami Database which provided 44 events that were reported as tsunamigenic (last download date : August 24, 2018). This list includes events like the February 27, 2010 Chile Mw 8.8 or the March 11, 2011 Japan Mw 9.1 earthquakes. The 44 tsunamigenic events represents 38.94% of the 113 events extracted from the USGS EQ database. From August 24, 2018 to January 10, 2019, 9 events have been extracted from the USGS database with the ~~algorithm decision table~~ and only 2 of them were followed by a NOAA PTWC bulletin indicating they triggered a tsunami.

Thus, there ~~were-is~~ 46 (44 + 2) tsunamigenic events for the period from September 29, 2009 to January 17, 2019, corresponding to 40.71% of the 113 identified earthquakes. From these 46 events, only 14 have been followed by a tsunami recorded in New Caledonia according to the observations included within PTWC bulletins.

An in-depth look at the other 32 events (46 - 14) case by case using both Tsunami Database and newspapers coupled to tide gauges data from the 8 local stations has been performed to identify small tsunamis that could have been missed by PTWC analysis (i.e., not mentioned in bulletins).

b) Looking on tide gauge data

From September 2009 to February 2011 ~~only the Nouméa tide gauge (Numbo) operated at high enough frequency to record any potential tsunami.~~ ~~Although~~ 8 extracted tsunamigenic earthquakes have been reported by PTWC bulletins ~~during this period, no one has been recorded on Numbo tide gauge, even the Mw 8.8 Bio-Bio, Chile, earthquake of February 27, 2010, recorded in nearby islands (Tonga, New Zealand, Australia, French Polynesia, etc.). As mentioned above, on this period only the Nouméa tide gauge operated at high enough frequency. But the analysis of the recorded signals at the Nouméa tide gauge for those 8 events, especially the Mw 8.8 Bio-Bio, Chile, earthquake of February 27, 2010, recorded in nearby islands (Tonga, New Zealand, Australia, French Polynesia, etc.), did not reveal any tsunami.~~

From February 2011 to January 2019, there are still 24 (32 - 8) tsunamigenic events extracted from the list. Hienghène and Ouinné tide gauges have been chosen to identify the corresponding recorded signals since these two tide gauges located on the East coast of the Grande Terre (Fig. 5) are exposed to several tsunami sources, and are located in bays or estuaries that could amplify tsunami signals. 7 of these 24 tsunamis have been

Formatted: Font: Not Bold

Formatted: Heading 2, Left, Line spacing: single

185 | recorded by Ouinné gauge but not reported in New Caledonia by PTWC. Among these 7 events, 2 did not even
trigger a PTWC bulletin (October 31, 2017 and November 01, 2017 events) although they are reported within
the NOAA NGDC catalogue.

190 | ~~The same analysis of local tide gauge signals for~~ For the 14 events reported by PTWC in New Caledonia showed
that only two of them were not recorded locally with certainty (probably an ambiguity with the background
noise): the July 18, 2015 Solomon and August 20, 2011 Vanuatu events. These two events are excluded.
Thus, there are 19 (12 + 7) tsunamis having been recorded in New Caledonia from September 30, 2009 to
January 10, 2019 with certainty. These 19 events are detailed on table 2.

195 | 3.1.2 Only recorded on tide gauges
An in-depth analysis of the sea-level data recorded at the Ouinné and Hienghène tide gauges for events extracted
by the ~~algorithm decision table~~ but not reported as tsunamigenic in the NOAA NGDC catalogue allows to find
additional tsunamis that were recorded in New Caledonia between September 30, 2009 and January 10, 2019.
Thus, on the 67 events (113 - 46) not identified as tsunamigenic by NOAA NGDC, 6 have still produced
tsunamis recorded on New Caledonia gauges. They are reported on table 2.

200 | 3.1.3 Results
Finally 25 new events ~~These 25 (19 + 6) events have been~~ represent a considerable update of the catalogue from
Sahal et al. (2010). It is important to note that aftershocks of powerful tsunamigenic earthquakes as the Mw 7.8
Kirakira, Solomon, earthquake of December 8, 2016, could also trigger tsunamis that would be drowned within
205 | the main shock tsunami signal. Also small tsunami signals could be covered by the background noise, especially
the coastal or offshore infragravity waves (Stephenson and Rabinovich, 2009, Aucan and Arduin, 2013).

210 | 3.2 Events before September 29, 2009
For the period before September 29, 2009, Sahal et al. (2010) have collected 18 events, including 12 events
related with certainty to an identified earthquake. These 12 events are detailed on table 3. There is a strong
uncertainty on the accuracy of the 6 other reported events concerning the date as well as the source (see section
e) below).

215 | 11 out of the 12 seismic events reported by Sahal et al. (2010) and shown in table 3 have been kept with the
~~algorithm decision table~~; the first one from 1875 is out of range from the USGS available database beginning on
January 01, 1900. These 11 events are part of the 854 extracted events by the ~~algorithm decision table~~ for the
period from January 01, 1900 to September 29, 2009 (included). It represents less than 1.29% of earthquake of
magnitude $M_w \geq 6.3$ being able to produce a tsunami reaching New Caledonia over this period.

220 | In comparison, for the period from September 30, 2009 to January 10, 2019, 25 of the 113 extracted events with
the ~~algorithm decision table~~ have produced a tsunami having reached New Caledonia. This represents 22.12% of
the earthquakes of magnitude $M_w \geq 6.3$.

Formatted: Heading 2, Left, Line
spacing: single

Formatted: Highlight

3.3 Comparison of the two periods

Even if we consider only the tsunamis reported in the NOAA NGDC catalogue, it corresponds respectively to 11 out of 854 events for the one hundred year period from January 01, 1900 to September 29, 2009 (included) and 14 out of 113 events for the ten year period from September 30, 2009 to January 10, 2019, i.e. 1.29% and 12.39%-. so an Nearly an increase by a factor of ten. This is likely due to the lack of tide gauge data before 2009 highlighting the importance of sea level data.

To compare exactly the 2 periods, we should consider the same number of days, i.e. 9 years, 3 months and 10 days. Thus from June 19, 2000 to September 29, 2009 the algorithm-decision table extracted 111 events potentially able to trigger tsunamis able to reach New Caledonia (this number is very close to the 113 events extracted after September 29, 2009 and to the 96 events extracted from march 9, 1991 to June 19, 2000). Cross-comparing those 111 events to the NOAA-NGDC tsunami database, it appears that 26 earthquakes triggered a tsunami on the Pacific Ocean, either local, regional or transoceanic. And from these 26 events, only 4 have been reported in New Caledonia according to Sahal et al. (2010).

3.42 Individual events during the 2009-2019 period

During this period, 4 events are particularly interesting as their records demonstrate the importance of local tide gauges and pressure sensors on tsunami hazard studies.

3.42.1 February 6, 2013 Solomon tsunami

The tsunami generated by the Santa Cruz, Solomon, Mw 8.0 earthquake of February 6, 2013 at 01:12:25 UTC was recorded at the Lifou tide gauge near 3 a.m. UTC (2 p.m. local time) and well observed by local witnesses (Fig. 6). The two pictures shown on figure 6 have been taken during the first wave maximum (a) and at the following minimum (b).

3.42.2 September 16, 2015 Chile tsunami

On September 16, 2015 at 22:54:32 UTC a magnitude Mw 8.3 earthquake in the region off Illapel, Chile triggered a transoceanic tsunami. After hours of propagation, it reached most of the South Pacific Ocean tide gauges. In New Caledonia it has been recorded on permanent tide gauge stations and pressure gauges about 16 hours after the earthquake as shown on Figure 7. This event is particularly interesting in the sense it confirms clearly that tsunamis are amplified near the Ouinné tide gauge, more ~~so~~ than at the other gauges (except Hienghène where unfortunately the beginning of the record is missing). At Poindimié two pressure gauges installed outside of the lagoon (Poindimié_Fourmi) and inside the lagoon close to the shore (Poindimié_Tieti) also recorded the tsunami. Data from the two gauges shows the wave shoaling probably also the amplification (up to 5 times) due to resonance inside the lagoon. Also, during this event a pressure gauge was rapidly installed in the Chaleix Naval Base at the location of the discontinued Chaleix tide gauge to compare the recorded signal to the Numbo tide gauge signal. The recorded signal at Chaleix was nearly three times higher than at Numbo's despite the close proximity of the two sites This emergency deployment allows to highlight the fact that there is a clear site effect in Nouméa's Bay, the signal at Chaleix being nearly three times more important than at Numbo(for location details, see Aucan et al., 2017a).

Formatted: Heading 2, Left, Line spacing: single

Formatted: Highlight

Formatted: English (U.K.)

Formatted: English (U.K.)

Formatted: English (U.K.)

Formatted: Highlight

3.42.3 November 19, 2017 South Vanuatu tsunami

Another example is given by three earthquakes that occurred during the November 19, 2017 seismic crisis located East of Mare Island: two very small tsunamis have been triggered by the Mw 6.3 and 6.6 foreshocks of the Mw 7.0 earthquake, which triggered a tsunami reaching a maximum amplitude of 0.8 m at Ouinné tide gauge. Despite their small amplitude, they are very well recorded and shown on figure 8.

3.42.4 December 5, 2018 Vanuatu tsunami

On December 5, 2018, a magnitude Mw 7.5 earthquake occurred at 04:18:08 UTC in the South of the Vanuatu subduction zone. Widely felt by the population in New Caledonia but also in the Vanuatu, a tsunami was soon recorded, firstly on the Loyalty Is. tide gauges (Maré and Lifou) and on all the other tide gauges within 1h30 after the main shock (Fig. 9). As it reached sometimes more than 1 m high according to eye-witnesses, this tsunami was also observed by numerous people for example in Yaté, close to Ouinné, on the Southeast coast of Grande Terre (Fig. 10a), and on the East coast of the Isle of Pines around the Méridien Resort and the Natural Pool touristic site where people have been evacuated (Fig. 10b).

3.53 Additional information on previously reported events

Five other events could be likely added to the herein catalogue. They come from testimonies and regional records (some of them have been already discussed in Sahal et al. (2010)).

3.35.1 Testimonies of tsunami events with unspecified date and not closely linked in time with any earthquake

The «1936» event reported in Northeast of the Grande Terre (north of Hienghène) with a 2 to 3 m runup could be due to a local landslide or possibly may be linked to the July 1934 North Vanuatu earthquake (Mw 7.8) which has triggered a tsunami observed in the same region (Hienghène-Touho).

The «May-July 1942 or 1943» large wave reported in Hienghène (2.5 m runup) and possibly the flooding «around 1940» reported on Isle of Pines (2 m runup) could be attributed to the same major event (although link between these reports is uncertain). No link could be made between these time periods and any earthquake. These events can be the result of landslides.

3.53.2 Testimonies of events with unspecified date but that can be linked to major local earthquake

The «December 1950 – February 1951» swelling and tidal wave reported at different localities by Sahal et al. (2010) along the east coast of the Grande Terre (Hienghène, Poindimié, Ponérihouen, Canala) and on Isle of Pines (Fig. 5) could be linked to the December 2, ~~1951~~ 1950 South Vanuatu large earthquake (Mw 7.9) which is one the largest events located close to New Caledonia and having generated a tsunami observed in Port Vila, Vanuatu (reference benard ?) and to the February 26-27, 1951 storm tide.

3.53.3 No record or testimony of worldwide or basin-wide events which are recorded especially in the vicinity of New Caledonia

The December 26, 2004 Indonesian tsunami (Mw 9.1 Sumatra earthquake) and the February 27, 2010 Chilean tsunami (Mw 8.8 Maule earthquake) were not reported in New Caledonia : there was only one tide gauge

Formatted: Highlight

operating in Nouméa in 2004 (e.g. Chaleix, sampled at a frequency of 1 hour) and in 2010 (e.g. Numbo, sampled at a frequency of 10 min)) although they have been well recorded in Tonga, New Zealand and Australia.

295 **3.5.3.4 May 22, 1960 Chile tsunami**

Although it has been already included within the catalogue from Sahal et al. (2010), the Great 1960 Chile tsunami was only reported through witness observations. Here we present a historical maregraphic record recovered in the SHOM archive, that shows this transoceanic tsunami recorded in Nouméa by the Chaleix tide gauge (Fig. 11). The tsunami amplitude is about 30 cm for the two primary waves.

300 **4 Discussion and conclusion**

4.1 Limitations of the methodology

This methodology using an extraction ~~algorithm~~-decision table is based only on the reported or recorded tsunamis generated by earthquakes and thus, do not considered tsunami triggered by landslides or, less frequently, by volcanic eruptions, representing respectively about 7% and 5% of the reported tsunamis of the NOAA tsunami database according to Harbitz et al. (2014). In the available data, there is no evidence of tsunamis related to active volcanism or landslides. Anyway, active submarine volcanoes exist in the neighborhood of New Caledonia, especially off the Loyalty Is. (Gemini seamounts, 200 km East of Maré and South of Aneytum, Vanuatu) on the Vanuatu volcanic arc. Besides, numerous submarine landslides have been mapped along the margins of Grande Terre and Loyalty Is.

305
310
315
Another limitation comes from the fact that we do not consider the tsunami amplitudes in this study. In fact, it is very difficult to estimate a maximum value for each event in New Caledonia, because of obvious lack in field observations for each one and absence of tide gauge in specific places, like the Isle of Pines where important tsunami run-ups have been reported for at least the December 5, 2018 event. A tsunami could have been lowly recorded by a tide gauge located in a protected area, for example in Nouméa harbor, although it has a strong impact on an exposed coast, for example on the East coast of the Isle of Pines. In addition, as detailed by Ioualalen et al. (2017), resonance phenomenon seem to play a predominant role on the tsunami behavior, especially in the Loyalty Is., depending directly on the source location and geometry. So, information concerning maximum observed amplitudes mentioned in table 2 and 3 gives just an idea of what happened during the reported events.

320 **4.2 Contributions for tsunami hazard assessment and risk management**

The 25 events are added to the 12 events from Sahal et al. (2010), leading to a list of 37 tsunamis reported or ~~recorded~~ for New Caledonia over the last 144 years. Besides the 1875 event (no exact location available), the 36 earthquake epicenters are shown on figure 12. As expected, it highlights 5 different tsunamigenic zones able to trigger tsunamis toward New Caledonia: locally, the Vanuatu subduction zone is responsible of 17/37 tsunamis, i.e. 45.94 %; at a regional scale, the Tonga-Kermadec subduction zone triggered 3/37 tsunamis, i.e. 8.1 % and the Solomon / Papua New Guinea subduction zone is responsible of 9/37, i.e. 24.32 %; and at an ocean scale the transoceanic tsunamis represents 8/37 events, i.e. 21.62 %.

Besides the December 17, 2016 PNG Mw 7.9 earthquake which hypocenter has been located ~100 km deep, the other earthquakes are located not deeper than 50 km.

330 Concerning tsunami amplitudes, their observed range varies to a few centimeters to several meters. Local tsunamis issued from South Vanuatu earthquakes impact mainly the Loyalty Is. and the South-east coast of Grande Terre (including the Isle of Pines) and are the most frequent and stronger. The north-eastern part of Grande Terre is more impacted by regional tsunamis coming from the North (Solomon and North Vanuatu subduction zones). Transoceanic tsunamis are also important to be considered in New Caledonia, able to produce
335 locally wave amplification of 1-2 m high.

A graphic representation of the 36 earthquakes showing magnitude (Mw) as a function of the distance between the epicenter location and the center of New Caledonia highlights 3 different groups (Fig. 13): the group of 8 earthquakes on the right corresponds without surprise to the transoceanic tsunamis; the group on the left corresponds to the local events from the southern Vanuatu subduction zone and the central group corresponds to
340 the regional events (Solomon, Northern Vanuatu and Tonga). In terms of risk managing, this study brings new constraints for alert thresholds:

- In a local field, with an epicenter located within a distance less than 500 km, only a magnitude $M_w \geq 6.3$ earthquake is able to trigger a tsunami toward New Caledonia coastlines.
- At a regional scale, i.e. at a distance of more than 1000 km, only the earthquakes with magnitude $M_w \geq 6.7$
345 would be considered as potentially hazardous for New Caledonia in terms of tsunami waves and currents.
- At a far field location, i.e. at a distance of more than 6000 km, only earthquakes with magnitude $M_w \geq 7.7$ would be considered as potentially hazardous for New Caledonia in terms of tsunami waves and currents.

4.3 Conclusion

This study allows to complete the tsunami catalogue of New Caledonia with 25 new events of seismic origin for
350 the period between September 30, 2009 and January 10, 2019: 19 already identified in the NOAA NGDC tsunami catalogue and 6 others recorded on New Caledonia gauges but not reported either in ~~the~~ NOAA NGDC catalogue ~~not nor~~ within the NOAA PTWC bulletins. The New Caledonia tsunami catalogue is now reaching a number of 37 tsunamis.

It also emphasizes that there is a considerable lack of tsunami information in New Caledonia for the pre-
355 September 2009 period concerning medium-magnitude events, due to the fact that there was less or no tide gauges and DART buoys able to record small tsunamis ~~and also because~~ there were less people living close to the shores. Note that there is no study dealing with paleotsunami in New Caledonia.

~~In addition~~ Finally, this study highlights clearly the value of tide gauges records, including old paper ones, and the necessity to settle the gauges in well identified locations, i.e. not always in sheltered areas but more in places
360 facing main tsunami pathways. It also brings to light the necessity to add more sensors in exposed areas like on the East coast of the Isle of Pines.

Acknowledgements

This study is part of a national project of tsunami hazard assessment funded by the local government of New Caledonia. The authors would like to thank the SHOM for providing tide gauge data

Formatted: Highlight

365 (<http://doi.org/10.17183/REFMAR>), and the ReefTEMPS coastal sea waters observation network for providing pressure gauge data (<http://doi.org/10.17882/55128>).

References

Aucan, J. and Arduin, F.: Infragravity waves in the deep ocean : An upward révision, *Geophysical Research Letters*, 40(13), 3435-3439, <https://doi.org/10.1002/grl.50321>, 2013.

370 Aucan, J., Merrifield, M.A. and Pouvreau, N.: Historical sea level in the South Pacific from rescued archives, geodetic measurements and satellite altimetry, *Pure and Applied Geophysics*, 174, 3813-3823, <https://doi.org/10.1007/s00024-017-1648-1>, 2017a.

Aucan, J., Vende-Leclerc, M., Dumas, P. and Bricqu岸, M.: Wave forcing and morphological changes of the New Caledonia lagoon islets, *Comptes Rendus Geosciences*, 349(6-7), 248-259, <https://doi.org/10.1016/j.crte.2017.09.003>, 2017b.

Baillard, C., Crawford, W.C., Ballu, V., Régnier, M., Pelletier, B. and Garaebiti, E.: Seismicity and shallow slab geometry in the central Vanuatu subduction zone, *Journal of Geophysical Research: Solid Earth*, 120, 5606-5623, <https://doi.org/10.1002/2014JB011853>, 2015.

380 Bevis, M., Taylor, F.W., Schuz B.E., Recy J., Isacks B.L., Helu S., Singh R., Kendrick E., Stowell J., Taylor B., Calmant S.: Geodetic observations of very rapid convergence and back-arc extension at the Tonga arc, *Nature* 374, 249-251, 1995.

Comment [J5]: added

Bolt, B.A., Horn, W.L., Macdonald, G.A. and Scott, R.F.: *Geological Hazards. Earthquakes - Tsunamis - Volcanoes - Avalanches - Landslides - Floods*, Springer-Verlag, 329 pp., 116 fig., <https://doi.org/10.1007/978-3-642-86820-7>, 1975.

385 Borrero, J.C., Legg, M.R. and Synolakis, C.E.: Tsunami sources in the southern California bight. *Geophysical Research Letters*, 31(13), L13211, <https://doi.org/10.1029/2004GL020078>, 2004.

Calmant S., Pelletier, B., Bevis, M., Taylor, F., Lebellegard, P., Phillips, D.: New insight on the tectonics of the New Hebrides subduction zone based on GPS results, *Journal of Geophysical Research*, 108, B6, 2316, <https://doi.org/10.1029/2001JB000644>, 2003.

Comment [J6]: added

390 DeMets, C., Gordon, R.G. and Argus, D.F.: Geologically current plate motions, *Geophysical Journal International*, 181(1), 1-80, <https://doi.org/10.1111/j.1365-246X.2009.04491.x>, 2010.

Faivre, J.-P.: Les origines de la colonisation française en Nouvelle-Calédonie, d'après un travail récent, in: *Journal de la Société des océanistes*, tome 6, 241-247, 1950.

395 Forestier, H.: Contribution à la connaissance du peuplement du Pacifique Sud-Ouest. L'industrie lithique des premiers mélanésiens de Nouvelle-Calédonie: Etude du site de Naia (Province sud) et quelques éléments de comparaison avec la région de Koumac (Province nord), *Mémoire de D.E.A., Institut de Paléontologie Humaine, MNHN, Paris*, 98 pp., 1994.

Glimsdal, S., Pedersen, G.K., Harbitz, C.B. and Lovholt, F.: Dispersion of tsunamis: does it really matter ? *Natural Hazards and Earth System Sciences*, 13, 1507-1526, <https://doi.org/10.5194/nhess-13-1507-2013>, 2013.

400 Harbitz, C.B., Lovholt, F., Bungum, H.: Submarine landslide tsunamis: how extreme and how likely? *Natural Hazards*, 72, 1341-1374, <https://doi.org/10.1007/s11069-013-0681-3>, 2014.

Comment [J7]: added

- Ioualalen, M., Pelletier, B. and Solis Gordillo, G.: Investigating the March 28th 1875 and the September 20th 1920 earthquakes/tsunamis of the Southern Vanuatu arc, offshore Loyalty Islands, New Caledonia, *Tectonophysics*, 709, 20-38, <https://doi.org/10.1016/j.tecto.2017.05.006>, 2017.
- 405 Legg, M.R. and Borrero, J.C.: Tsunami potential of major restraining bends along submarine strike-slip faults, ITS 2001 Proceedings, session 1, Number 1-9, 331-342, 2001.
- Louat, R. and Baldassari, C.: Chronologie des séismes et des tsunamis ressentis dans la région Vanuatu Nouvelle-Calédonie (1729-1989), *Rapports Scientifiques et Techniques, Sciences de la Terre, ORSTOM Nouméa*, 1, 48 pp., 1989.
- 410 Pelletier B., Louat, R.: Mouvements relatifs des plaques dans le Sud-Ouest Pacifique, *C.R. Acad. Sci. Paris*, t.308, série II, p.123-130, 1989.
- Pelletier B., Calmant, S., Pillet, R.: Current tectonics of the Tonga-New Hebrides region, *Earth Planet. Sci. Lett.* 164, 263-276, 1998.
- Rabinovich, A.B. and Thomson, R.E.: The 26 December 2004 Sumatra tsunami: analysis of tide gauge data from the World Ocean Part 1. Indian Ocean and South Africa, in: *Tsunami and its hazards in the Indian and Pacific Oceans*, edited by :Satake et al., 261-308, <https://doi.org/10.1007/s00024-006-0164-5>, 2007.
- Rabinovich, A.B., Candella, R.N. and Thomson, R.E.: The open ocean energy decay of three recent trans-Pacific tsunamis, *Geophysical Research Letters*, 40, 3157-3162, <https://doi.org/10.1002/grl.50625>, 2013.
- Sahal, A., Pelletier, B., Chatelier, J., Lavigne, F. and Schindelé, F.: A catalog of tsunamis in New Caledonia from 28 March 1875 to 30 September 2009, *Comptes Rendus Geoscience*, 342, 434-447, <https://doi.org/10.1016/j.crte.2010.01.013>, 2010.
- Soloviev, S.L. and Go, C.H.N.: Catalogue of tsunamis on the western shore of the Pacific Ocean, *Canadian Translation of Fisheries and Aquatic Sciences*, 5077, 439 pp., 1984.
- Stephenson, F.E. and Rabinovich, A.B.: Tsunamis on the Pacific Coast of Canada recorded in 1994-2007, *Pure and Applied Geophysics*, 166(1-2), 177-210, <https://doi.org/10.1007/s00024-008-0440-7>, 2009.
- Tanioka, Y., Cabrera Ramirez, A.G. and Yamanaka, Y.: Simulation of a dispersive tsunami due to the 2016 El Salvador-Nicaragua outer-rise earthquake (Mw 6.9), *Pure and Applied Geophysics*, 175, 1363-1370, <https://doi.org/10.1007/s00024-018-1773-5>, 2018.
- Tanioka, Y. and Satake, K.: Tsunami generation by horizontal displacement of ocean bottom, *Geophysical Research Letters*, 23(8), 861-864, <https://doi.org/10.1029/96GL00736>, 1996.
- Tinti, S.: Evaluation of tsunami hazard in Calabria and Eastern Sicily, Italy, in: *Tsunamis in the World*, edited by: S. Tinti, 141-157, 1991.
- Titov, V., Rabinovich, A.B., Mofjeld, H.O., Thomson, R.E. and Gonzalez, F.I.: The global reach of the 26 December 2004 Sumatra tsunami. *Science*, 309, 2045-2048, <https://doi.org/10.1126/science.1116505>, 2005.
- 435 UNESCO/IOC: Operational Users Guide for the Pacific Tsunami Warning and Mitigation System (PTWS), IOC Technical Series, No 87, Second Edition, 2009.
- U.S. Geological Survey: Earthquake catalog, accessed January 10, 2019 at URL <https://earthquake.usgs.gov/earthquakes/search/>, 2019.
- Varillon, D., Fiat, S., Magron, F., Allenbach, M., Hoibian, T., De Ramon N'Yeurt, A., Ganachaud, A., Aucan, J., Pelletier, B. and Hocdé, R.: ReefTEMPS: the observation network of the coastal sea waters of the South, West and South-West Pacific, *SEANOE*, <https://doi.org/10.17882/55128>, 2018.
- 440

Comment [J8]: added

Comment [J9]: added

Walker, D.A.: Ocean-wide tsunamis, magnitude thresholds, and 1946 type events, *Science of Tsunami Hazards*, 23(2), 3-8, 2005.

445 Ward, S.: Relationships of tsunami generation and an earthquake source, *Journal of Physics of the Earth*, 28, 441-474, <https://doi.org/10.4294/jpe1952.28.441>, 1980.

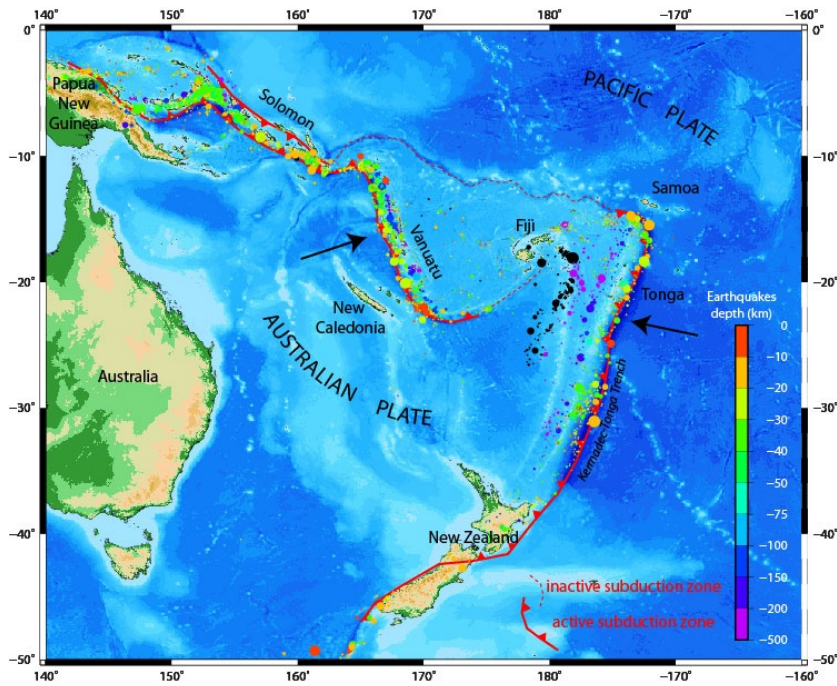

450 Figure 1: Regional tectonic settings around New Caledonia. The colored dots represent $M_w \geq 6.0$ earthquakes recorded since January 01, 1900 and their sizes are function of magnitude. The black arrows symbolize the relative motion of the Australian and Pacific plates (cm/yr).

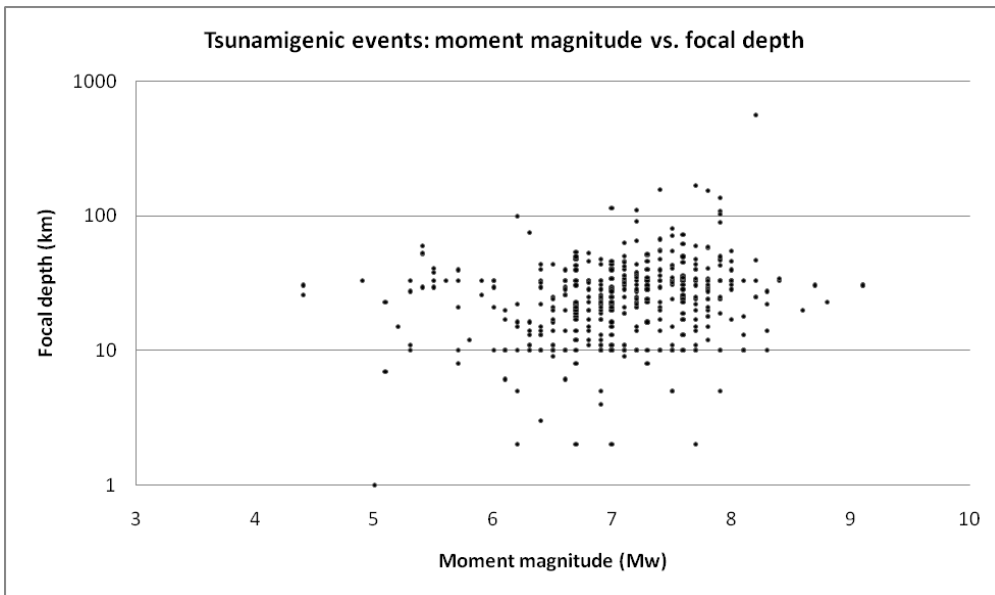
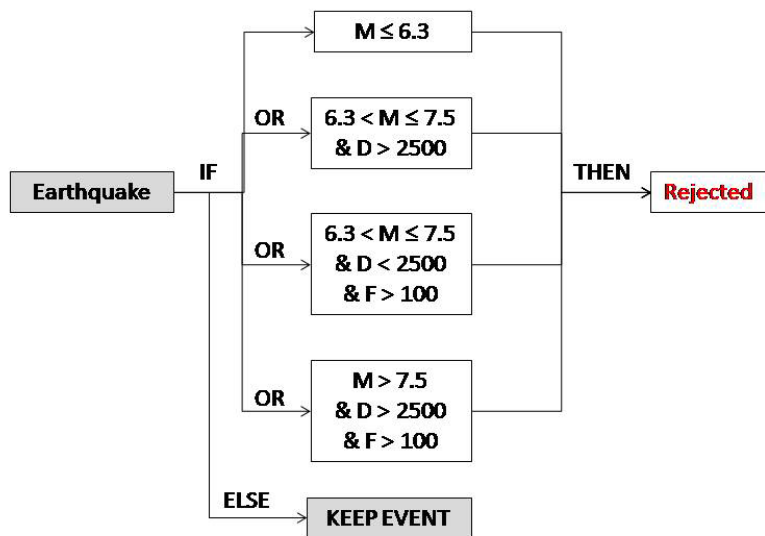

Figure 2 : Relationship between earthquake focal depth and moment magnitude for 440 tsunamigenic events of the NGDC/WDS Global Historical Tsunami Database.

455



Figure 3 : 2500 km around New Caledonia (Credit: Google 2018, Landsat/Copernicus Image).



460 Figure 4 : Decision algorithm-table to select events automatically.

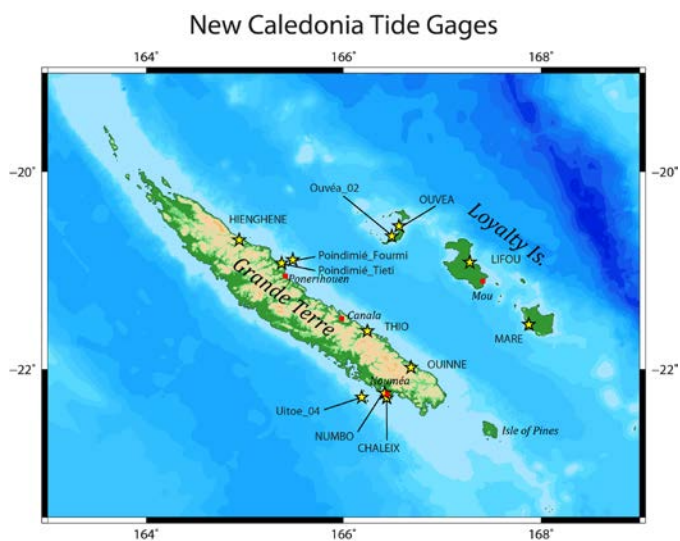
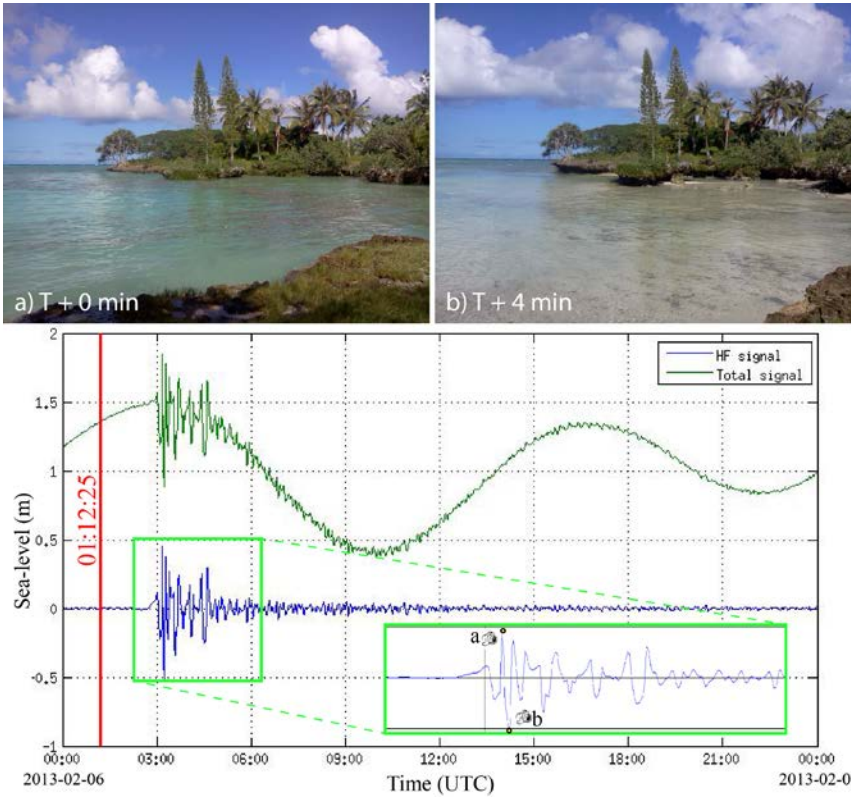
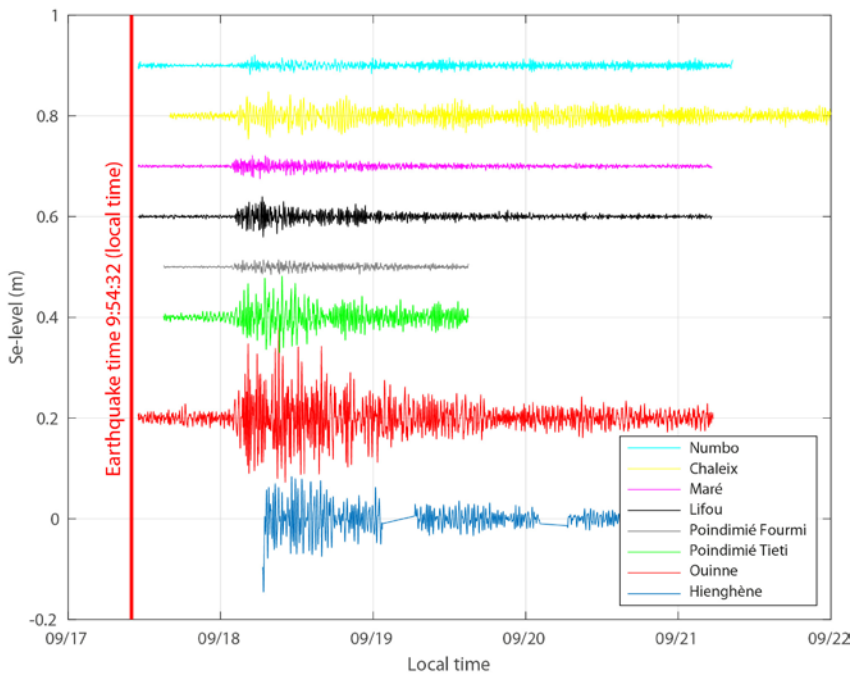

Figure 5: New Caledonia tide and pressure gauges (yellow stars).



465

Figure 6 : The February 6, 2013 Solomon tsunami record on Lifou tide gauge (green: raw signal; blue: filtered). The red line locates the earthquake time. The two pictures have been taken at Mou (on the South-eastern coast of Lifou) at the maximum (a) and minimum (b) sea levels and located on the green inset focusing on the main tsunami signal (Photos courtesy of Matthieu Le Duff).



470

Figure 7 : Sea level variations recorded on tide and pressure gauges in New Caledonia following the 2015 Illapel, Chile, earthquake.

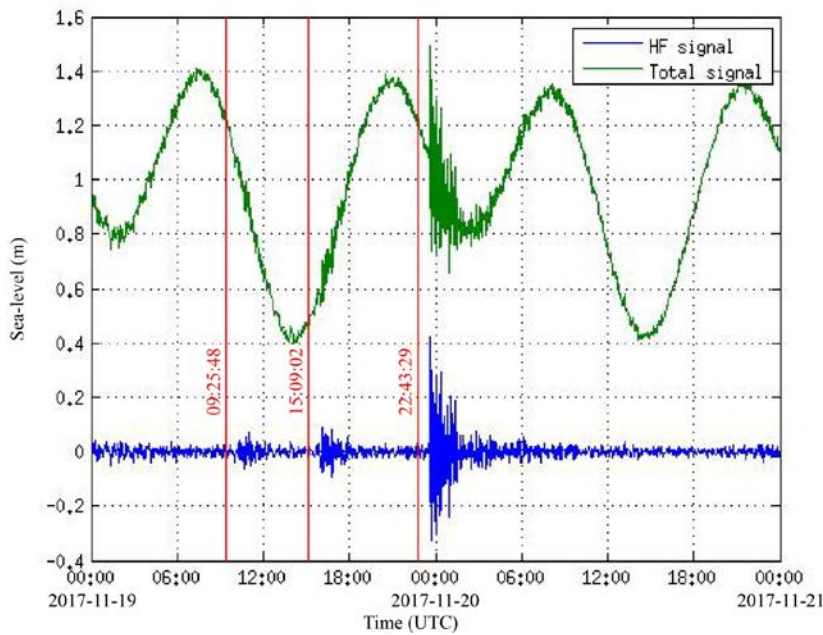

475

Figure 8 : The triplet of tsunamis of November 19, 2017 recorded at Ouinné tide gauge. On the blue graphic the tide signal (visible on the green graphic) has been filtered. The red lines locate the times of the three different earthquakes.

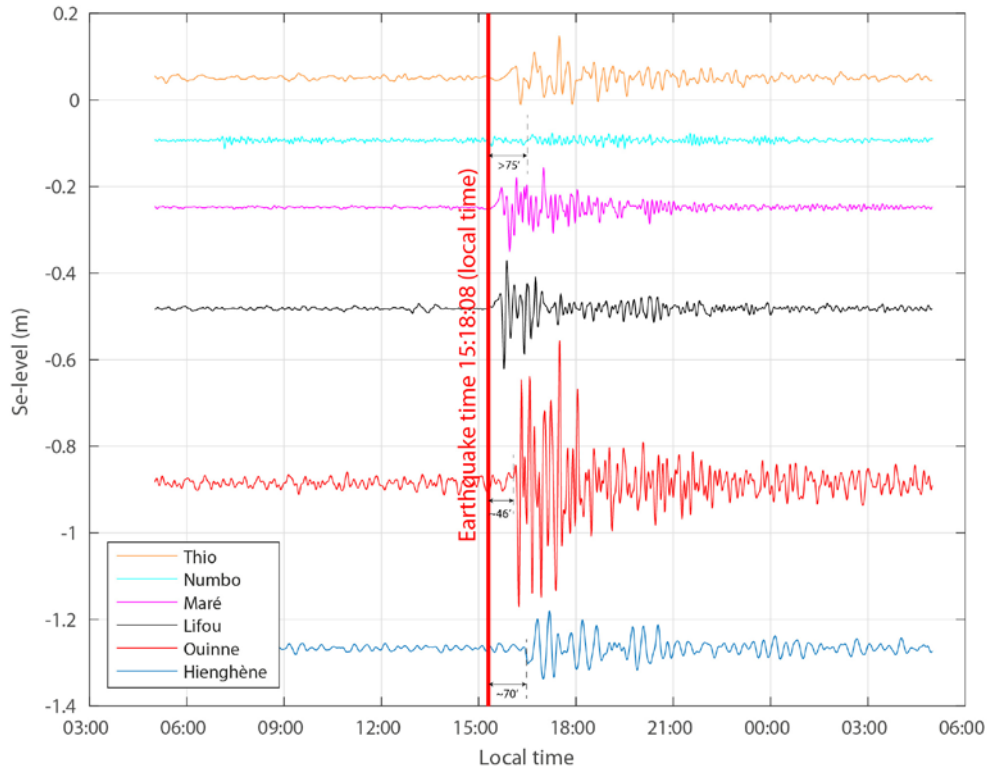

Figure 9 : Sea level variations recorded on tide and pressure gauges in New Caledonia following the 2018 Vanuatu earthquake.



480 Figure 10 : Arrival of the December 5, 2018 tsunami in a) Yaté after the first withdrawal of the sea (Courtesy of Rose-Mai Néa) and b) at the bridge linking the Méridien Resort island to the Isle of Pines (Courtesy of Moana Bretault).

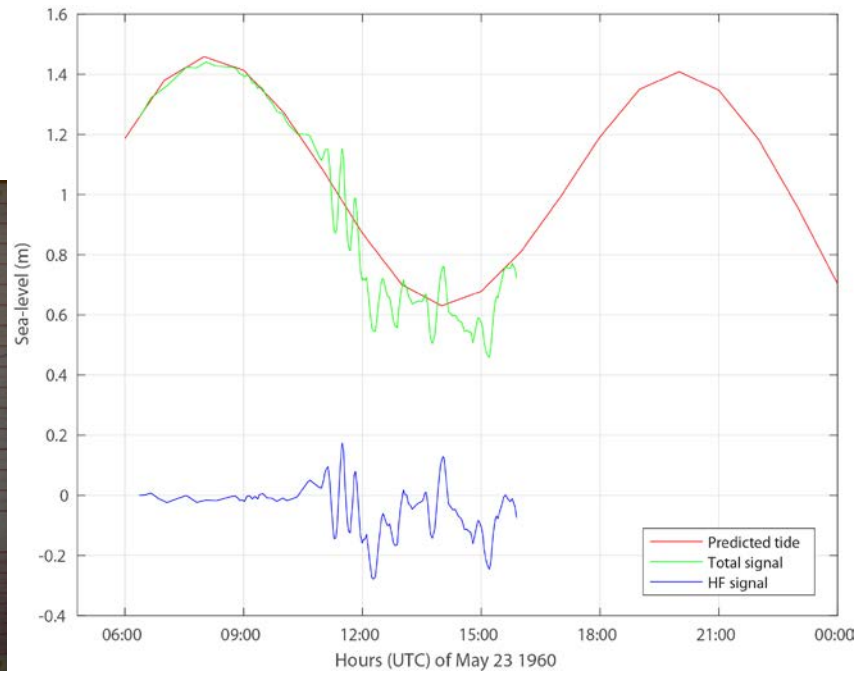
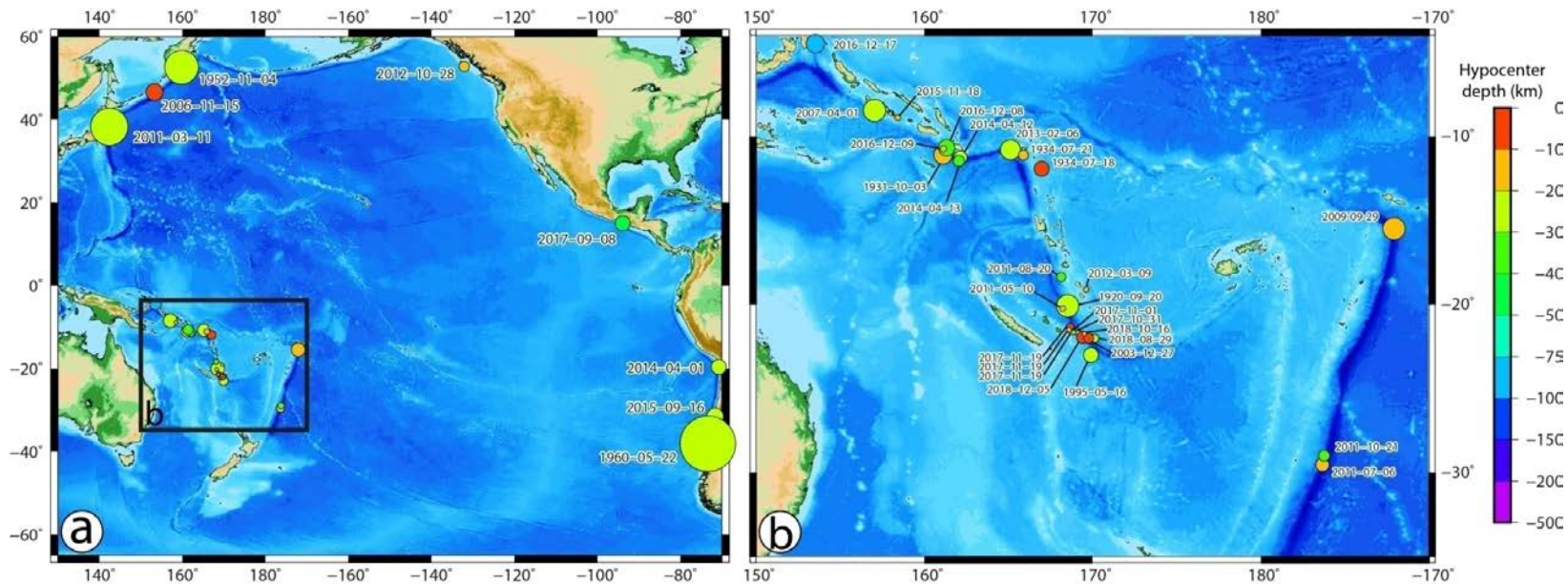

Figure 11 : Tide gauge record of the 1960 Chile tsunami in Nouméa (Chaleix station): original record (left) and digitized signal (right), total (in green) and detided (in blue).



485

Figure 12 : Location of the epicenter of earthquakes having triggered tsunamis ~~able to be~~ reported or /recorded in New Caledonia. a) Over the whole Pacific Ocean highlighting source locations of transoceanic tsunamis ; b) at a regional scale, highlighting regional and local sources.

couper la color scale

Formatted: Highlight

490

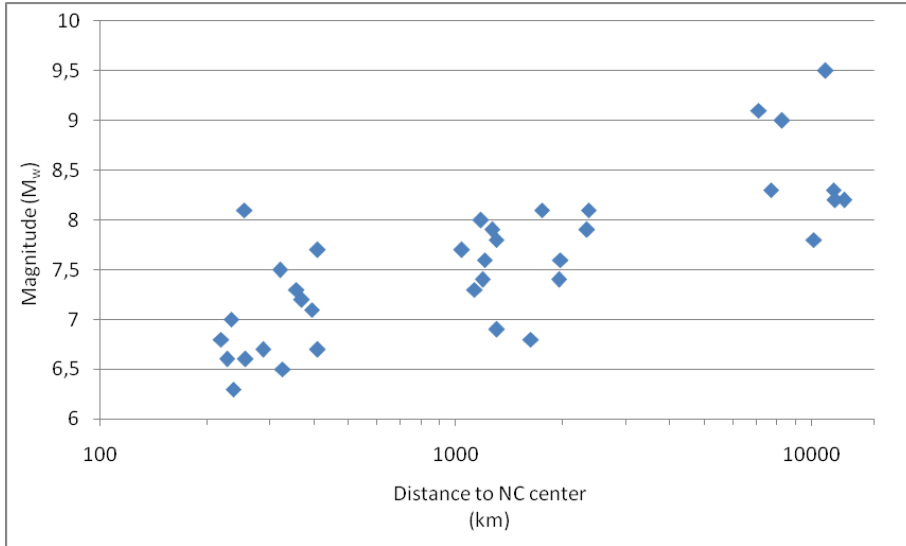

Figure 13 : Graphic representation of the new catalogue showing earthquake's magnitude (M_w) as functions of distance between epicenter and New Caledonia.

495 **Table 1 : Permanent tide gage locations and pressure sensors in New Caledonia.**

Type	Longitude (°)	Latitude (°)	Name	in-operation date	First available high frequency (<5 min.) observation (SHOM)	Date of last available data
Tide gage stations	166.436742	-22.291478	CHALEIX (Nouméa)	24/02/1967	None except pre 1967 paper records	2005
	166.241528	-21.613806	THIO	09/06/1967	23/04/2015	
	167.27869444	-20.918472	LIFOU	08/09/1969	22/05/2013	
	166.561867	-20.549816	OUVEA	06/04/1981	27/10/2011	
	166.68327646	-21.982877	QUINNE	30/08/1981	17/05/2011	
	167.8771	-21.5478	MARE	26/10/1982	22/04/2012	
	164.943122	-20.691993	HIENGHENE	13/12/1983	23/02/2011	
	166.416218	-22.241966	NUMBO (Nouméa)	29/07/2001	07/10/2010	
Pressure sensors	166.1832	-22.285866	Uitoe_04	24/06/2016	24/06/2016	14/11/2018
	166.48825	-20.653333	Ouvéa_02	23/09/2013	23/09/2013	04/04/2014
	165.322034	-20.928805	Poindimié_Tieti	18/09/2013	01/11/2013	20/07/2016
	165.484807	-20.891997	Poindimié_Fourmi	01/11/2013	01/11/2013	15/05/2017

Table 2 : 25 tsunamis recorded in New Caledonia between September 30, 2009 and January 10, 2019. The 6 last events have not been reported as tsunamigenic in the NOAA NGDC catalogue.

	Earthquake time	Longitude (°)	Latitude (°)	Magnitude (M _w)	Hypocenter depth (km)	Location (subduction zones)	USGS ID	Distance to NC Center (km)	Observed maximum amplitude (cm)
NOAA NGDC/WDS Global Historical Tsunami Database	2011-03-11T05:46:24.120Z	142,373	38,297	9,1	29	Japan	official20110311054624120_30	7089	100 (Ouinné)
	2011-07-06T19:03:18.260Z	183,66	-29,539	7,6	17	Kermadec	usp000j48h	1959	20 (Ouinné)
	2011-08-20T16:55:02.810Z	168,143	-18,365	7,2	32	Vanuatu (South)	usp000j6r4	368	25 (Ouinné)
	2011-10-21T17:57:16.100Z	183,762	-28,993	7,4	33	Kermadec	usp000j9nm	1945	10 (Ouinné)
	2012-10-28T03:04:08.820Z	227,899	52,788	7,8	14	Cascadia	usp000juhz	10142	5 (Hienghène)
	2013-02-06T01:12:25.830Z	165,114	-10,799	8	24	Vanuatu (North) - Santa Cruz earthquake (Sol.)	usc000f1s0	1171	120 (Ouinné/Hienghène)
	2014-04-01T23:46:47.260Z	289,2309	-19,6097	8,2	25	Chile	usc000nzvd	12326	20 (Ouinné)
	2014-04-12T20:14:39.300Z	162,1481	-11,2701	7,6	22,56	Solomon	usc000phx5	1201	10 (Ouinné/Hienghène)
	2014-04-13T12:36:19.230Z	162,0511	-11,4633	7,4	39	Solomon	usc000pij	1185	15 (Ouinné/Hienghène)
	2015-09-16T22:54:32.860Z	288,3256	-31,5729	8,3	22,44	Chile	us20003k7a	11497	40 (Ouinné)
	2016-12-08T17:38:46.280Z	161,3273	-10,6812	7,8	40	Solomon	us20007z80	1296	70 (Hienghène)
	2016-12-09T19:10:06.840Z	161,1316	-10,749	6,9	19,73	Solomon	us20007z1q	1298	10 (Hienghène)
	2016-12-17T10:51:10.500Z	153,5216	-4,5049	7,9	94,54	PNG	us200081v8	2328	10 (Hienghène)
	2017-09-08T04:49:19.180Z	266,1007	15,0222	8,2	47,39	Mexico	us2000ahv0	11598	15 (Ouinné)
	2017-10-31T00:42:08.720Z	169,1485	-21,6971	6,7	24	Vanuatu (South)	us1000aytk	286	30 (Ouinné)
	2017-11-01T02:23:57.670Z	168,8585	-21,6484	6,6	22	Vanuatu (South)	us1000azjt	255	15 (Ouinné)
	2017-11-19T22:43:29.250Z	168,6715	-21,3246	7	10	Vanuatu (South)	us2000brlf	232	70 (Ouinné)
	2018-08-29T03:51:56.100Z	170,1262	-22,0295	7,1	21,43	Vanuatu (South)	us1000gjaz	392	40 (Ouinné)
2018-12-05T04:18:08.410Z	169,4181	-21,9558	7,5	10	Vanuatu (South)	us1000i2gt	319	200 (Isle of Pines)	
2018-10-16T01:03:43.580Z	169,5217	-21,7427	6,5	17	Vanuatu (South)	us1000hclz	325	10 (Ouinné)	
Local tide gages only	2011-05-10T08:55:08.930Z	168,226	-20,244	6,8	11	Vanuatu (South)	usp000j1a8	218	5 (Ouinné)
	2012-03-09T07:09:50.950Z	169,613	-19,125	6,7	16	Vanuatu (South)	usp000jftzj	408	10 (Ouinné)
	2015-11-18T18:31:04.570Z	158,4217	-8,8994	6,8	12,59	Solomon	us10003zcp	1620	20 (Ouinné)
	2017-11-19T09:25:48.730Z	168,6729	-21,6377	6,3	14	Vanuatu (South)	us2000brbk	236	10 (Ouinné)
	2017-11-19T15:09:02.880Z	168,5984	-21,5027	6,6	13	Vanuatu (South)	us2000brgk	226	15 (Ouinné)

Table 3 : List of tsunamis and associated seismic origins reported in New Caledonia from Soloviev and Go (1974) and Sahal et al. (2010). Observed maximum amplitudes have been estimated from witness observations.

Area concerned	Tsunami arrival in New Caledonia (Sahal et al., 2010)	Earthquake magnitude (Sahal et al., 2010)	Source of tsunami	Earthquake time (UTC)	Epicenter coordinates (USGS)		USGS earthquake magnitude (Mw)	Hypocenter depth (km)	USGS ID	Distance to NC center (km)	Observed maximum amplitude (cm)
					Longitude (°)	Latitude (°)					
Local	28/03/1875	8.1-8.2*	Vanuatu (South)	1875-03-28T12:00:00.000	no information						> 250 (Lifou)
	21/09/1920	8	Vanuatu (South)	1920-09-20T14:39:03.000Z	168,523	20,088	8,1	25	iscgem912618	253	100-500 (Ouvéa)
	17/05/1995	7,7	E of Walpole Is.	1995-05-16T20:12:44.220Z	169,9	23,008	7,7	20,2	usp0006xg1	408	50 (Maré)
	28/12/2003	7,3	Vanuatu (South)	2003-12-27T16:00:59.450Z	169,766	22,015	7,3	10	usp000cg90	355	50 (Maré)
Regional	04/10/1931	7	Solomon	1931-10-03T19:13:22.000Z	161,11	11,117	7,9	15	iscgem907054	1262	150 (Hienghène)
	19/07/1934	7,8	Vanuatu (North)	1934-07-18T19:40:19.000Z	166,977	11,936	7,7	10	iscgem905046	1038	130 (Touho, Poindimié, Hienghène)
	21/07/1934	7	Vanuatu (North)	1934-07-21T06:18:22.000Z	165,89	11,129	7,3	15	iscgem905065	1128	100 (Touho)
	02/04/2007	8	Solomon	2007-04-01T20:39:58.710Z	157,043	-8,466	8,1	24	usp000f83m	1743	200 (Hienghène)
Trans oceanic	05/11/1952	9	Kamchatka	1952-11-04T16:58:30.000Z	159,779	52,623	9	21,6	official19521104165830_30	8248	200 (Yaté)
	23/05/1960	9,5	Chile	1960-05-22T19:11:20.000Z	286,593	38,143	9,5	25	official19600522191120_30	10943	100 (Yaté)
	15/11/2006	8,3	Kuril	2006-11-15T11:14:13.570Z	153,266	46,592	8,3	10	usp000exfn	7667	50 (Quinné)
	30/09/2009	8,1	Tonga	2009-09-29T17:48:10.990Z	187,905	15,489	8,1	18	usp000h1ys	2355	50 (Quinné)

* Information from Ioualalen and Pelletier (2017)